

Errata

Title & Document Type: 1630A/D/G Logic Analyzer Operating and Programming Manual

Manual Part Number: 01630-90915

Revision Date: October 1985

HP References in this Manual

This manual may contain references to HP or Hewlett-Packard. Please note that Hewlett-Packard's former test and measurement, semiconductor products and chemical analysis businesses are now part of Agilent Technologies. We have made no changes to this manual copy. The HP XXXX referred to in this document is now the Agilent XXXX. For example, model number HP8648A is now model number Agilent 8648A.

About this Manual

We've added this manual to the Agilent website in an effort to help you support your product. This manual provides the best information we could find. It may be incomplete or contain dated information, and the scan quality may not be ideal. If we find a better copy in the future, we will add it to the Agilent website.

Support for Your Product

Agilent no longer sells or supports this product. You will find any other available product information on the Agilent Test & Measurement website:

www.tm.agilent.com

Search for the model number of this product, and the resulting product page will guide you to any available information. Our service centers may be able to perform calibration if no repair parts are needed, but no other support from Agilent is available.

OPERATING AND PROGRAMMING MANUAL

Model 1630A/D/G LOGIC ANALYZER

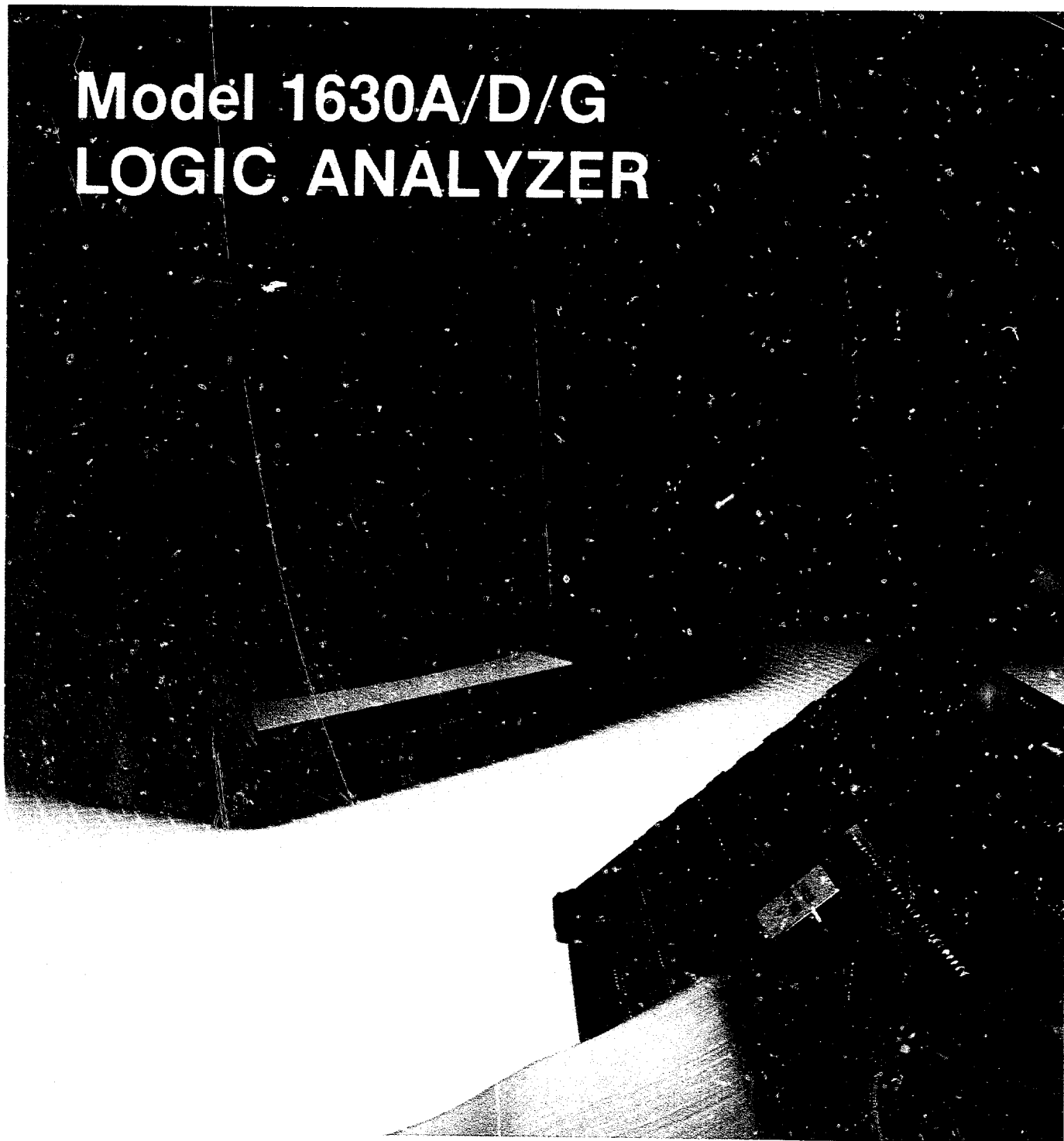

HEWLETT
PACKARD



OPERATING AND PROGRAMMING MANUAL

HP LOGIC ANALYZERS

MODELS 1630A/D/G

This manual applies to **Models 1630A/D (Option 007) and all 1630G** instruments. It also applies to **1630A** instruments serial prefixed **2424A and below**, and **1630D** instruments serial prefixed **2428A and below**.

©COPYRIGHT HEWLETT-PACKARD COMPANY/COLORADO SPRINGS DIVISION 1985
1900 GARDEN OF THE GODS ROAD, COLORADO SPRINGS, COLORADO, U.S.A.

ALL RIGHTS RESERVED

SAFETY SUMMARY

The following general safety precautions must be observed during all phases of operation, service, and repair of this instrument. Failure to comply with these precautions or with specific warnings elsewhere in this manual violates safety standards of design, manufacture, and intended use of the instrument. Hewlett-Packard Company assumes no liability for the customer's failure to comply with these requirements.

GROUND THE INSTRUMENT.

To minimize shock hazard, the instrument chassis and cabinet must be connected to an electrical ground. The instrument is equipped with a three-conductor ac power cable. The power cable must either be plugged into an approved three-contact electrical outlet or used with a three-contact to two-contact adapter with the grounding wire (green) firmly connected to an electrical ground (safety ground) at the power outlet. The power jack and mating plug of the power cable meet International Electrotechnical Commission (IEC) safety standards.

DO NOT OPERATE IN AN EXPLOSIVE ATMOSPHERE.

Do not operate the instrument in the presence of flammable gases or fumes. Operation of any electrical instrument in such an environment constitutes a definite safety hazard.

KEEP AWAY FROM LIVE CIRCUITS.

Operating personnel must not remove instrument covers. Component replacement and internal adjustments must be made by qualified maintenance personnel. Do not replace components with power cable connected. Under certain conditions, dangerous voltages may exist even with the power cable removed. To avoid injuries, always disconnect power and discharge circuits before touching them.

DO NOT SERVICE OR ADJUST ALONE.

Do not attempt internal service or adjustment unless another person, capable of rendering first aid and resuscitation, is present.

USE CAUTION WHEN EXPOSING OR HANDLING THE CRT.

Breakage of the Cathode-ray Tube (CRT) causes a high-velocity scattering of glass fragments (implosion). To prevent CRT implosion, avoid rough handling or jarring of the instrument. Handling of the CRT shall be done only by qualified maintenance personnel using approved safety mask and gloves.

DO NOT SUBSTITUTE PARTS OR MODIFY INSTRUMENT.

Because of the danger of introducing additional hazards, do not install substitute parts or perform any unauthorized modification of the instrument. Return the instrument to a Hewlett-Packard Sales and Service Office for service and repair to ensure that safety features are maintained.

DANGEROUS PROCEDURE WARNINGS.

Warnings, such as the example below, precede potentially dangerous procedures throughout this manual. Instructions contained in the warnings must be followed.

WARNING

**Dangerous voltages, capable of causing death, are present in this instrument.
Use extreme caution when handling, testing, and adjusting.**

1630A/D/G Operating and Programming Manual

Table of Contents

Chapter 1. General Information

Introduction	1-1
Manual Contents	1-1
Analyzer Description	1-1
State Analysis	1-2
Timing Analysis	1-2
Internal Storage	1-3
The System Specification	1-3
The Format Specification	1-3
The Trace Specification	1-3
List Displays	1-3
Waveform Displays	1-3
Chart Displays	1-3
Physical Configurations	1-4
Analyzer Memory	1-4

Chapter 2. Installation

Introduction	2-1
Initial Inspection	2-1
Power Requirements	2-1
Line Voltage Selection	2-2
AC Power Cable	2-2
Operator's Maintenance	2-2
Site Selection	2-2
Rear Panel Address Switch	2-2
Rear Panel BNC Connectors	2-3
Connecting Operating Power	2-3
Applying Operating Power	2-3
Self-Test	2-4
1630A/D Self-Test	2-4
1630G Self-Test	2-4
Connecting Analyzer To Target System	2-6
Connecting Analyzer Through Probe Interface	2-6
Connecting Probes Directly To Target System	2-6

Chapter 3. Front Panel Controls and Menu Map

Introduction	3-1
State Measurements	3-1
Timing Measurements	3-1
Interactive State/Timing Measurements	3-1

Chapter 4. State Measurements

Introduction	4-1
Capturing A State Trace	4-1
The State Format Specification	4-4
The State [Assignment] Format Specification	4-4

Chapter 4. State Measurements (Cont'd)

The State [Relocation] Format Specification	4-10
The State [User Base] Format Specification	4-13
Inverse Assemblers For The Logic Analyzer	4-15
The State Trace Specification	4-15
Resource Terms	4-19
Sequential Triggering	4-22
[Compare/Edit Compare/Full Compare] Trace Modes	4-27
The State Display	4-31
List Displays	4-31
Waveform Displays	4-33
XY Charts Of Label Activity	4-34

Chapter 5. Performance Analysis Measurements

Introduction	5-1
State Label Overview Measurement	5-1
Time Interval Overview Measurement	5-4
Time Positional Measurements	5-6
Linkage Overview Measurements	5-10

Chapter 6. Timing Measurements

Introduction	6-1
Glitches	6-1
Triggering	6-1
Simple Timing Measurements	6-1
Activating The Timing Analyzer	6-1
Controlling The Timing Display	6-3
Selecting Trace Positions On The Display	6-4
Triggering On A Timing Event	6-5
The Timing Format Specification	6-7
Timing Format Specification [Assignment]	6-7
Timing Format Specification [User Base]	6-8
The Timing Trace Specification	6-9
[Single] Timing Trace Specification	6-9
[Continuous] Timing Trace Specification	6-9
The Timing Display	6-10
Waveform Displays	6-10
List Displays	6-11
Chart Displays	6-12

Chapter 7. Interactive State And Timing Measurements

Introduction	7-1
The Format Specification	7-1
The Trace Specification	7-1
Interactive State/Timing Displays	7-1
Interactive State/Timing Triggering	7-1
Special Use For Stop Key	7-2
Making Coordinated State And Timing Measurements	7-2
Setup For State And Timing Measurements	7-2
Executing Coordinated Measurements	7-4

Chapter 8. The Peripherals Menus

[Peripherals] System Configuration	8-1
1630A/D System [Peripherals] Specification Menu	8-1
1630G System [Peripherals] Specification Menu	8-2

Chapter 9. Using HP-IB Or HP-IL Interface

Introduction	9-1
HP-IB and HP-IL Interface Capabilities	9-1
Keyboard Mnemonics	9-2
Data Formats	9-5
Data Formatting Examples	9-6
HP 1630A/D Learn String Commands	9-10
TC - Transmit Configuration Learn String	9-10
TS - Transmit State Acquisition Learn String	9-10
TT - Transmit Timing Acquisition Learn String	9-14
TE - Transmit Everything Learn String	9-15
Data Transfer Termination	9-15
HP 1630G Learn String Commands	9-15
TC - Transmit Configuration Learn String	9-15
TS - Transmit State Acquisition Learn String	9-16
TT - Transmit Timing Acquisition Learn String	9-21
TE - Transmit Everything Learn String	9-22
Data Transfer Termination	9-22

Appendix A. Display Messages**Appendix B. An HP-IB Overview**

Introduction	B-1
HP-IB System Terms	B-1
Interface Bus Concepts	B-1
Message Concepts	B-2
The HP Interface Bus	B-3
HP-IB Lines And Operations	B-3
Interface Functions	B-5
Bus Messages	B-6
HP 1630 HP-IB Implementation	B-6

Appendix C. Using A Printer

Introduction	C-1
Obtaining Hard Copy From A Printer	C-1
Using A Controller To Operate The Analyzer And Printer	C-2

Appendix D. Using The Disc Memory Accessory

Introduction	D-1
Connecting The 9121 D/S Flexible Disc Drive	D-1
The Storage Operations Menu	D-1
How To Read A Disc File	D-2
How To Create A New Disc File	D-3
How To Find A Disc File	D-3
How To Delete A Disc File	D-4
How To Load An Inverse Assembler From Disc To Internal Storage	D-4
How To Format A Disc	D-5

Appendix E. Using The Tape Memory Accessory

Introduction	E-1
How To Use Tape Memory Accessory	E-1
How To Create A New File	E-4
How To Read A File	E-4
How To Copy An Existing File From One Tape To Another	E-4

Index

List of Illustrations

Figure 3-1. 1630 Front Panel Controls	3-2
Figure 3-2. Input/Output Displays Menu Map	3-3
Figure 4-1a. 1630D Default System Specification Menu	4-2
Figure 4-1b. 1630G Default System Specification Menu	4-2
Figure 4-2a. Free-Run State Trace Captured By The 1630A/D	4-2
Figure 4-2b. Free-Run State Trace Captured By The 1630G	4-3
Figure 4-3a. 1630A/D Default State Format Specification Menu	4-4
Figure 4-3b. 1630G Default State Format Specification Menu	4-5
Figure 4-4. 1630G State Listing Including The ADDR Label	4-7
Figure 4-5a. 1630A/D State [Assignment] Format Specification Menu	4-7
Figure 4-5b. 1630G State [Assignment] Format Specification Menu	4-8
Figure 4-6a. 1630A/D State Listing For ADDR, DATA, And STAT Labels	4-8
Figure 4-6b. 1630G State Listing For ADDR, DATA, and STAT Labels	4-9
Figure 4-7. State Assignment With Bits Assigned To Multiple Labels	4-9
Figure 4-8. State Listing With Bits Assigned To Multiple Labels	4-10
Figure 4-9. Default State [Relocation] Format Specification Menu	4-11
Figure 4-10. State [Relocation] Format Specification With Assigned Modules	
Figure 4-11. State Listing Using Relocation Values	4-12
Figure 4-12. State Listing With Relocation And Absolute Value Lists	4-13
Figure 4-13. State [User Base] Format Specification Menu	4-13
Figure 4-14. User Base Specification With Assigned Conditions To STAT Label	4-14
Figure 4-15. State Listing With User Base Names In STAT List	4-14
Figure 4-16. State Listing With Disassembled Data List	4-15
Figure 4-17. 1630G Default State Trace Specification Menu	4-16
Figure 4-18. 1630G State Listing With Count States List	4-17
Figure 4-19. 1630G State Listing With States List In Absolute Values	4-17
Figure 4-20. State Listing With Specific States Marked	4-18
Figure 4-21. State Listing Showing Only A Specific State	4-18
Figure 4-22. The State Trace Specification With Fields For Resource Terms	4-20
Figure 4-23. Specification Of Trigger On First Occurrence Of A Specific State	4-20
Figure 4-24. Trigger Starts Trace Listing	4-20
Figure 4-25. Trigger Centers Trace State Listing	4-21
Figure 4-26. Trigger Ends Trace State Listing	4-21
Figure 4-27. Branching Network With Specified Paths	4-22
Figure 4-28. State Trace Specification With Sequence Terms	4-23
Figure 4-29. State Trace Specification With [next to] Sequence Terms	4-23
Figure 4-30. State Trace Specification With Sequence Terms And ORed Trigger Starts Terms	4-24
Figure 4-31. Maximum Sequence Restart ORed Resource Terms	4-25
Figure 4-32. ORed Resource Terms As Store Qualifiers When Trigger Starts Trace	4-25
Figure 4-33. Store Qualifying Data Between Sequence Terms	4-26
Figure 4-34. Maximum Amount Of Resource Terms For The State Trace Specification	4-27

List of Illustrations (Cont'd)

Figure 4-35. [Compare/Edit Compare] State Trace Specification	4-28
Figure 4-36. The [Compare/Edit Compare] List	4-28
Figure 4-37. Trace Taken In Compare [until ≠] Mode	4-29
Figure 4-38. Original Compare List With Compare Event Differences	4-29
Figure 4-39. [Full Compare] State Trace Specification	4-30
Figure 4-40. Typical List Display In Single Trace Mode	4-31
Figure 4-41. Typical List Display In Compare Trace Mode	4-32
Figure 4-42. Typical State Waveform Display	4-33
Figure 4-43. Typical State XY Chart Of A Label	4-34
Figure 5-1. Example State Label Overview Trace Specification	5-3
Figure 5-2. State Label Overview Chart Of Example Measurement	5-4
Figure 5-3. Example State Time Interval Overview Trace Specification	5-5
Figure 5-4. State Time Interval Overview Chart Of Example Measurement	5-6
Figure 5-5. Example State Time-Positional Trace specification	5-7
Figure 5-6. State Time Positional Overview Chart Of Example Measurement	5-8
Figure 5-7. State Time Positional Listing for Example Measurement	5-9
Figure 5-8. Example State Linkage Trace Specification	5-11
Figure 5-9. State Linkage Overview Chart For Example Measurement	5-12
Figure 6-1. Selecting The Timing Analyzer Configuration Of The 1630D (1630A and 1630G Have 8 Less Channels)	6-2
Figure 6-2. Default Timing Measurement For 1630D (1630A and 1630G Have 8 Less Channels)	6-2
Figure 6-3. Magnification Around "x"	6-3
Figure 6-4. Selecting Waveform Positions On Display	6-5
Figure 6-5. Triggering On A Pattern And Edge Transition	6-6
Figure 6-6. Triggering On A Timing Event	6-6
Figure 6-7. Timing Assignment Format Specification	6-7
Figure 6-8. Timing User Base Format Specification	6-8
Figure 6-9. Timing Trace Specification (With [Glitch] Selected)	6-9
Figure 6-10. Typical Timing Waveform Display	6-10
Figure 6-11. Typical List Display Of Timing Activity	6-11
Figure 6-12. Typical Timing XY Chart Of A Label	6-12
Figure 7-1. Combined State/Timing Analyzer System Configuration for The 1630G	7-2
Figure 7-2. State Assignment Format Specification	7-3
Figure 7-3. State Trace Specification In State/Timing Measurements	7-3
Figure 7-4. State Trace Specification With Trigger In Row "b"	7-4
Figure 7-5. Timing Trace Specification For Combined State/Timing Measurements	7-5
Figure 7-6. Timing Waveform Display	7-6
Figure 7-7. Timing Trace Specification With Master [Timing]	7-6
Figure 7-8. Timng Listing Display	7-7
Figure 8-1. 1630A/D [Peripherals] System Specification	8-1
Figure 8-2. 1630G System [Peripherals] Specification Menu Without Internally Stored Information ...	8-2
Figure 8-3. 1630G System [Peripherals] Specification Menu With Internally Stored Information	8-4
Figure D-1. The [Storage Operations] Menu	D-2
Figure E-1. Tape Operations System Menu	E-2

List of Tables

Table 1-1. Specifications	1-5
Table 1-2. Operating Characteristics	1-7
Table 4-1. Address Map For Relocation Example	4-10
Table 4-2. User Base Names For STAT Label	4-14
Table 9-1. HP-IB/HP-IL Keyboard Mnemonics	9-2

Chapter 1. General Information

Introduction	1-1
Manual Contents	1-1
Analyzer Description	1-1
State Analysis	1-2
Timing Analysis	1-2
Internal Storage	1-3
The System Specification	1-3
The Format Specification	1-3
The Trace Specification	1-3
List Displays	1-3
Waveform Displays	1-3
Chart Displays	1-3
Physical Configurations	1-4
Analyzer Memory	1-4

Chapter 1

General Information

INTRODUCTION

This manual describes how to operate the Hewlett-Packard Models 1630A, 1630D, and 1630G Logic Analyzers. The three analyzers operate the same, but each have different configuration capabilities. The 1630G is the latest configuration with added performance measurement capabilities that are not possible with the 1630A or 1630D logic analyzers. The differences are described, wherever applicable, throughout this manual. This first chapter describes the physical and electrical characteristics of the analyzer. At the end of this chapter are two tables: one lists the analyzer specifications guaranteed by HP, and the other lists the analyzer operating characteristics.

MANUAL CONTENTS

This manual contains instructions and information to help you install and operate the logic analyzer. It shows how to assign labels in the format specification to identify signals from the input probes, and how to assign symbols to represent values found on those labeled inputs.

Chapter 2 describes how to set up the logic analyzer for use. Directions are given for connecting the probe cables to a system under test and initiating the analyzer self test.

Chapter 3 contains a menu map and a front panel keyboard description. The menu map helps to put the overall operation of the analyzer into perspective. Page numbers are given by each menu to reference the description of the menu in the manual.

Chapter 4 of this manual is State Measurements. The basic state measurements, from taking a trace in a free-run mode to selective tracing, is explained in a step-by-step process.

Chapter 5 contains the software performance analysis measurements. Although these measurements are state measurements, an entire chapter is devoted to them because of the complexity of overview analysis.

Chapter 6 is a description of the timing measurements. Simple timing measurements are described in a step-by-step process.

Chapter 7 describes interactive state/timing measurements.

Chapter 8 is a description of the system peripheral menus of the 1630A/D and the 1630G.

Chapter 9 contains the instructions used for programming the 1630 logic analyzers via HP-IB or HP-IL.

Appendix A contains all the possible display messages that may appear on the analyzer screen. An HP-IB overview is given in Appendix B for use as a reference for programming over the HP-IB. Appendices C, D, and E explain using a printer, tape memory, or disc memory accessories with the logic analyzer.

ANALYZER DESCRIPTION

Logic analyzers perform trace measurements. The HP 1630A/D/G models are interactive state and timing analyzers for use in the design and troubleshooting of microprocessor based systems. An analyzer traces activity from several points during a period of system operating time. The analyzer may perform both state and timing measurements together and interactively control the capture of information in each of these two functions.

The analyzer can perform overview measurements with which the performance of code modules in software-intensive systems may then be analyzed. Overview measurements available in all three 1630 models include state and time interval histograms. The 1630G has added overview measurement features that enhance the state label histogram and allow time position and linkage measurements. The logic analyzers can be described as having two basic functions, that of state and timing, and have special features in each function which are listed below.

State Analysis

The state analysis function of each model features:

- Continuous trace until compare "equal to" or "not equal to" is provided. The compare file is the width of the analyzer, and has depth of up to 16 words with the 1630A/D and in the edit compare mode of the 1630G. The 1630G has a full compare mode in which the entire trace may be compared.
- Three ORed clocks given in single-phase or two-phase demultiplexing modes.
- Data sampling up to 25 MHz.
- 1024 states available in memory after a trace.
- A State Chart of any user-defined label may be selected for display.
- State analysis can be armed by the timing analysis section.
- A State Histogram of any user-defined label may be selected.
- A Time Interval Histogram of the time software takes to execute from one selected point in software to another.
- Time Positional measurements for the occurrences of an event per unit time may be made. (1630G only)
- Linkage measurements which show the relative frequency of occurrence of a set of events. (1630G only)

Timing Analysis

The timing analysis function of each system features:

- Sampling ranges from 10 nS to 500 mS, in increments of 1, 2, and 5.
- Timing waveforms that can be magnified from X1 to X40 in 1, 2, and 4 increments.
- Time between dual cursors (x and o) can be displayed to within 1 sample period.
- 1024 samples available in memory after a trace.
- Timing analysis can be armed by the state analysis section.
- Timing can be triggered by an asynchronous pattern, ANDed with a glitch or edge on any channel, and patterns that exceed or fall short of a specified time limit.

INTERNAL STORAGE

The 1630G has the added feature of an internal storage space which allows the user to store menu configurations and an inverse assembler. One configuration of each menu and one inverse assembler may be stored at one time. The stored configurations and inverse assemblers may be specified for automatic loading at power-up of the 1630G.

THE SYSTEM SPECIFICATION

Use the menus in this specification to identify how the analyzer will be used: whether as a state analyzer, a timing analyzer (with or without glitch capture), or a combined state and timing analyzer. In this menu, you also identify the way the analyzer will operate when used as part of a system, or when using capabilities offered by accessories.

THE FORMAT SPECIFICATION

Use the menus in this specification to set up the way the analyzer formulates displays from its captured information. You can label individual bits or sets of bits, and assign names to identify address ranges and/or specific values found in those labeled sets. The analyzer will compose displays using your labels and names, if desired.

THE TRACE SPECIFICATION

Use the menus in this specification to enter parameters for making your measurements. You can set up the analyzer to trace state flow and/or record electrical activity at nodes in a system under test. The analyzer can also perform overview measurements to gauge the efficiency of selected software routines.

LIST DISPLAYS

The analyzer composes lists of information captured from labeled sets of bits. These lists show a series of software executions, and/or a sequence of electrical activities at nodes in a system under test. Values shown in these lists can be expressed using names of your choice, as well as using numbers in the binary, octal, decimal, and hexadecimal number bases. Values can also be expressed as ASCII codes for labels having from 6 to 16 bits.

WAVEFORM DISPLAYS

The waveform display shows up to 16 individual traces of electrical activity on selected bits. Each trace is shown as a continuous line of high and low states. The waveform shows how the states changed with time at each monitored point. You can also see points on the traces where glitches were detected during the measurement, if desired. Glitch detection is accomplished by internally combining two timing channels attached to a single probe, using one channel for data values, and using one of the channels as a glitch detector.

CHART DISPLAYS

The analyzer can format two types of chart displays: XY charts, and histograms. XY charts show a plot of the flow of values on a labeled set of bits. You can control the horizontal and vertical scales of the chart to examine the details around areas of interest on the XY chart.

Histogram charts are bar graphs used to measure the performance of software modules in a system under test. The analyzer can show two types of histograms: state label histograms, and time interval histograms. A state label histogram shows the relative number of executions within each range of states you define. Up to eight ranges of states can be defined for a label histogram. Time interval histograms show eight time ranges; you can define the period of each range. You can set up the analyzer to make time interval measurements each time the software executes from one selected point to another in the system under test. The time interval histogram shows how often execution of the selected software module was completed within each of the time ranges you defined.

PHYSICAL CONFIGURATIONS

The following is a list of the analyzer configurations, components, and optional accessories:

1. HP Model 1630A Logic Analyzer. Offers 35 channels for state, timing, and combined state/timing measurements.
2. HP Model 1630D Logic Analyzer. Same as 1630A, except offers 8 additional channels for state and timing measurements.
3. HP Model 1630G Logic Analyzer. Same as 1630A, except offers 30 additional channels for state measurements.
4. HP Model 10271A General Purpose State Probe. Nine channels for collecting state activity plus an input clock channel. Used to supply state activity only. Three state probes are supplied with the 1630A/D/G.
5. HP Model 10272A General Purpose State/Timing Probe. Eight channels for collecting state activity or timing activity. No input clock channel. One state/timing probe is supplied with either 1630A or 1630G and two are supplied with the 1630D.
6. HP Model 10273A General Purpose State Probe. 10 channels for collecting state activity. Three state probes are supplied with the 1630G.
7. HP Model 82161A Digital Cassette Drive. Optional accessory for Models 1630A/D used to store instrument setups and captured data in tape memory.
8. HP Model 9121D/S Flexible Disc Drive. Optional accessory for Model 1630G to store instrument setups and captured data in disc memory.
9. HP Model 10269A Probe Interface (for Models 1630A/D) with HP preprocessor option. HP option used to make all connections to interface the analyzer to a specific microprocessor.
10. HP Model 10269B Probe Interface (for Models 1630A/D/G) with HP preprocessor option. Second generation 10269A with added connections to interface the 1630G to a specific microprocessor.
11. HP Model 10340A modification kit to modify Models 1630A/D to a Model 1630G configuration.

The following accessories are supplied with the 1630 Logic Analyzers:

- 1630A: Three 9-bit 10271A State Probes and one 8-bit 10272A State/Timing Probe.
 1630D: Three 9-bit 10271A State Probes and two 8-bit 10272A State/Timing Probes.
 1630G: Three 9-bit 10271A State Probes, one 8-bit 10272A State/Timing Probe and three 10-bit 10273A State Probes.
 1630A/D/G: One 2.3 meter (7.5 ft) power cord. One Operating and Programming Manual.

ANALYZER MEMORY

The trace memory of the analyzer is 1024 states deep. It stores each qualified state captured by the input probes. The trace memory also stores measurements of time for the timing listing so you can analyze periods between occurrences of interest.

The compare memory of the 1630A/D, and of the 1630G, (when in [Edit Compare] mode), is sixteen states deep. It can store up to sixteen lines for comparison with the corresponding lines in the trace memory. The compare memory of the 1630G, when in [Full Compare] mode, is 1024 states deep and an entire trace may be compared with the compare memory.

Table 1-1. Specifications

Measurement Configurations

	STATE	TIMING
1630A:	35	0
	0	8
	27	8
1630D:	43	0
	0	16
	35	8
	27	16
1630G:	65	0
	0	8
	57	8

Note: Number of timing channels halved in Glitch mode.

Measurement Functions

Memory

- Data Acquisition: 1024 words.
- Compare: 16 words (1630A/D, 1630G in [Edit Compare] mode). Entire trace for 1630G in [Full Compare] mode.
- Search: Memory may be searched for any pattern defined within a label set. All pattern matches in memory may be marked or separately displayed.

Input Specifications

Clock repetition rate

- Single Phase: 25 MHz with single clock and single edge specified.
20 MHz with any ORed combination of clocks and edges.
- Multiplexed: Master Slave clock timing. Master clock must follow slave clock by at least 10 ns and precede next slave clock by 50 ns or more.

Clock Pulse Width: ≥ 10 ns at threshold.

RC: 100 kilohms $\pm 2\%$ shunted by approx 5 pF at probe body.

Setup time: time data must be present prior to clock transition, ≥ 20 ns.

Hold time: time data must be present after clock transition, 0 ns.

Minimum swing: 600 mV p-p.

Minimum input overdrive: 250 mV or 30% of input amplitude, whichever is greater.

Maximum voltage: ± 40 volts, peak.

Threshold Range: -9.9 volts to $+9.9$ volts in 0.1-volt increments. Accuracy $2.5\% \pm 120$ mV.

Dynamic Range: ± 10 volts about threshold.

Skew: Between channels in one pod: ≤ 6 ns.

Between channels in different pods: ≤ 10 ns.

(These specifications are true for input signal, $V_H = -1.0V$, $V_L = -1.6V$, V_{TH} at $-1.3V$, slew rate greater than 0.25 V/ns.)

Glitch: With glitch detection on, number of timing channels are halved. Minimum detectable glitch: 5 nsec width at threshold.

Table 1-1. Specifications (Cont'd)

Operating environment

- Temperature: 0° to 55° C (32° to 131° F), 20° to 30° C recommended.
- Humidity: up to 95% relative humidity at +40° C, 40% to 80% relative humidity recommended.
- Altitude: to 4600 m (15,000 ft).
- Vibration: vibrated in three planes for 15 min. each with 0.3 mm excursions, 5 to 55 Hz.
- Dimensions: dimensions are for general information only. If dimensions are required for building special enclosures, contact your HP field engineer. Dimensions are in millimetres and (inches).

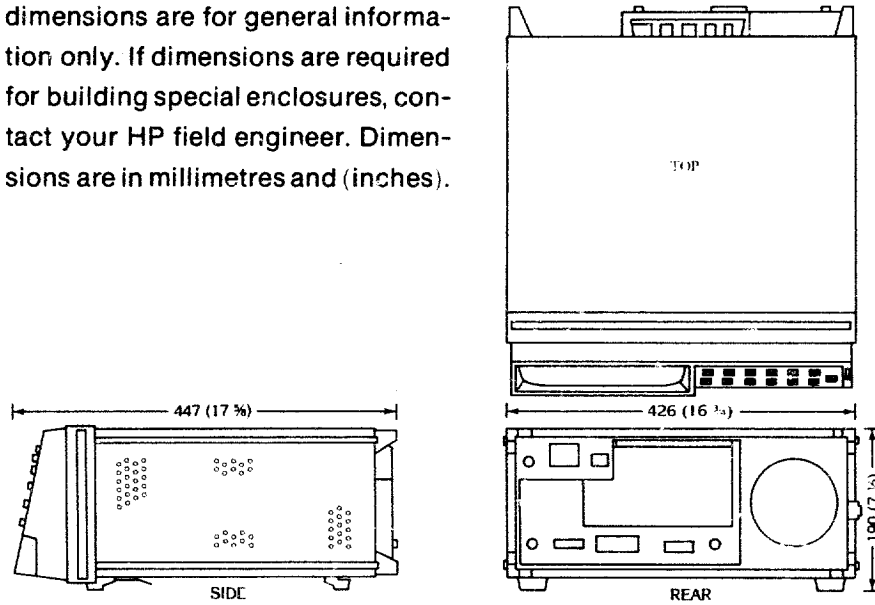

Table 1-2. Operating Characteristics

State Mode	
Clocks:	three ORed clocks operate in single-phase or two-phase demultiplexing mode. Clock edge is selectable as positive, negative, or both edges for each clock. Different edge selections may be made on the same clock if used in each phase of the multiplexed mode.
Data Indexing	
Resources:	four terms including the Boolean NOT of each term, ALL patterns, or NO pattern. (A term is the AND combination of bit patterns in each label.) Terms may be used as often as desired.
Trigger:	up to four resource terms may be used in sequence to establish the trace parameter. The last term in the sequence may use up to four resource terms in an ORed format.
Restart:	one to four resource terms may be used in an ORed condition for a sequence-restart condition.
Store qualifiers:	one to four resource terms may be used in an ORed format. Store qualification may be separately defined for each term in the trigger sequence.
Occurrence:	occurrence of the last event in the sequence may be specified up to $n = 59999$.
Compare:	trace until compare "equal to" or "not equal to" is provided. The compare file is the width of the analyzer, with a depth up to 16 words in the 1630A/D and in the 1630G in the [Edit Compare] mode. When the 1630G is in the [Full Compare] mode, an entire trace may be compared. Each word in the compare buffer can have "don't cares" and can be compared anywhere in the 1024 deep memory.
Arming:	the state analyzer can be armed by the full Data Indexing capability of the Timing Analyzer.
Overview	
XY Chart:	a chart of any user-defined label can be shown. The user can change the upper and lower bounds of the chart, and all 1024 states of the memory can be simultaneously displayed.
Time measurement:	a timer can be started on completion of a sequence of up to three resource terms with restart and occurrence capability like state data indexing. The timer can be stopped and/or restarted on OR'd combinations of one to four resource terms. A histogram of the start/stop time measurement is displayed. The user can specify up to eight time ranges. Minimum time, maximum time, average time, last time, total time, and total samples are also displayed. Resolution - displayed statistics 250 ns or 0.1% of reading, whichever is greater, (4-digit display). Histogram ranges: 1 usec.
State histogram:	a histogram of any user-defined label can be shown. The user can specify up to eight labels and ranges. Maximum Count - approx $2(E63)$.
Time position measurement:	produces a time-varying profile of system activity. Measurements are the number of occurrences of an event per unit time. The measurement is used to understand the behavior of systems under time-varying loads.
Linkage measurement:	the relative frequency of direct transfers between module pairs are depicted in a histogram for identification of light or heavy transfer. Modifications of software may then be made to optimize program efficiency. Resolution - actual count is rounded to 0.1% (4-digit display).

Table 1-2. Operating Characteristics (Cont'd)

Timing mode

Clock

Ranges: 10 ns to 500 ms in 1, 2, 5 sequence.
 Accuracy: $\pm 0.01\%$.

Data Indexing

Asynchronous

pattern: 20 ns to 1 ms in 1, 2, 5 sequence with an accuracy of $\pm 20\%$ or 15 ns, whichever is greater.

Glitch or edge on any channels AND'd with asynchronous pattern.

Maximum time

delay: approx $2(E18)$ times the sample period to a maximum of 9999 sec.

Arming: the timing analyzer may be armed by the full data indexing capability of the state analyzer.

Markers: time between dual markers (x and o) is displayed to accuracy of one sample period.

Expansion: X1 to X40 in 1, 2, 4 sequence. Display is a compressed representation of the 1K memory in X1 magnification. In X2 magnification, each displayed sample represents a single sample in memory.

Overview: a chart of any user-defined label can be shown. The user can change the upper and lower bounds of the chart, and all 1024 states of the memory can be simultaneously displayed.

General Characteristics

Labels

Input channel

labels: up to 8 state, 16 timing, user-defined, 5-character labels may be assigned bit patterns in any configuration. Bits may be used in more than one label and need not be contiguous. Primary use is for identifying bits assigned to bus structures such as Address, Data, and Status.

User field: all labels with 4 bits or less allow mnemonics to be assigned to specific patterns. Primary use is to identify such functions as Read, Write, Op Code, etc.

Relocatable field: any single state label may be defined to have relocatable properties to facilitate viewing software modules in the format they were written. Up to 16 module starting locations may be specified, allowing trigger parameters to be based on module names, plus an offset value. An onboard calculator that operates in hex, octal, binary, or decimal facilitates general offset calculations.

Time-of-day-clock: 24-hour clock prints out time of data collection on all stored records.

Activity Markers: provided in format display for quick identification of active inputs.

Outputs

HP-IB:

HP-IB connector with 8-position HP-IB switch located on rear panel. Five positions on switch are used to determine address, 2 positions used to determine TALK ONLY mode for hardcopy, or system controller.

HP-IB can be used in following environments:

1. Logic analyzer being controlled from a controller, such as HP 9826A. Maximum bus transfer rate is approximately 4K bytes per second.
2. Stand-alone hard copy on a graphics printer, such as HP 2671G.
3. Storage of user setups and measurement results on a disc memory accessory.

Table 1-2. Operating Characteristics (Cont'd)

HP-IL:	<p>HP-IL connector located on rear panel for HP-IL control, or for interfacing to HP 82161A, low-cost mini-cassette drive. Not required to use analyzer, but enhances analyzer operation as follows:</p> <ol style="list-style-type: none"> 1. Storage of user setups and measurement results; 10 different files can be stored on one cassette. 2. When coupled with an appropriate preprocessor, allows analyzer to assume a processor-specific personality to present data in mnemonic format.
Rear-panel BNCs:	<p>one output BNC labeled PORT, located on rear panel, with a TTL output level; high =2V into 50 ohms; low =0.4V into 50 ohms. The BNC can be programmed from the keyboard to provide the following signals:</p> <ol style="list-style-type: none"> 1. Pulse on State Trace Point. 2. High until State Trace Point. 3. Low until State Trace Point. 4. High on last Sequence. 5. High on Timing Pattern. 6. Constant High. 7. Constant Low. <p>one BNC labeled ACCESSORY POWER supplies +5V for preprocessor or logic probes.</p>
Weight:	<p>1630A: 12.6 kg (28 lb) net; 17 kg (38 lb) shipping. 1630D: 13.2 kg (29 lb) net; 17.7 kg (39 lb) shipping. 1630G: 13.6 kg (30 lb) net; 18.14 kg (40 lb) shipping.</p>
Power requirement:	115/230 Vac, -22% to +10%; 275W max. 48 to 66 Hz.
Service And Calibration Support:	<p>The 1630A/D/G contains all necessary interfaces to allow high-speed troubleshooting and calibration with automatic equipment. Guided probe techniques, utilizing signature analysis under computer control, coupled with special test instruments and fixtures allow most failures to be isolated to the component level in a minimum amount of time. After repair, full and complete calibration can be accomplished in minutes, using the same equipment. Since this integrated design can only be serviced efficiently and economically with this automated system, all major HP service facilities have installed this special equipment. This HP investment will provide you with the fastest, most complete and lowest cost repairs and calibrations. For those companies where economies of scale make in-house repair and calibration cost-effective, an option is available that provides the special hardware, software and related documentation and training to allow 1630A/D/G repair. Additional test equipment is required. Contact your local HP sales representative for further information.</p>

Chapter 2. Installation

Introduction	2-1
Initial Inspection	2-1
Power Requirements	2-1
Line Voltage Selection	2-2
AC Power Cable	2-2
Operator's Maintenance	2-2
Site Selection	2-2
Rear Panel Address Switch	2-2
Rear Panel BNC Connectors	2-3
Connecting Operating Power	2-3
Applying Operating Power	2-3
Self-Test	2-4
1630A/D Self-Test	2-4
1630G Self-Test	2-4
Connecting Analyzer To Target System	2-6
Connecting Analyzer Through Probe Interface	2-6
Connecting Probes Directly To Target System	2-6

Chapter 2 Installation

INTRODUCTION

The purpose of this chapter is to describe how the analyzer is set up and the probe cables are connected for measurements in a system under test. The self test of the analyzer and messages that may be displayed during the self-test are also described.

INITIAL INSPECTION

WARNING

To avoid hazardous electrical shock, do not perform electrical tests when there are signs of shipping damage to any portion of the outer enclosures of the instrument (covers and panels).

Inspect the shipping container for damage. If the shipping container or cushioning material is damaged, it should be kept until the contents of the shipment have been inspected mechanically and electrically. If the contents are incomplete, if there is mechanical damage or defect, or if the instrument does not pass the self test, notify your nearest Hewlett-Packard Sales and Service Office. If the shipping container is damaged, or the cushioning materials show signs of stress, notify the carrier as well as the Hewlett-Packard office. Keep the shipping materials for inspection by the carrier.

POWER REQUIREMENTS

The 1630A/D/G Logic Analyzer requires a power source of either 115 or 230 Vac $-22%$ to $+10%$; single phase, 48 to 66 Hz; 275 watts maximum power.

WARNING

This is a Safety Class I product (provided with a protective earth terminal). An uninterruptible safety earth ground must be provided from the main power source to the product input wiring terminals, power cord, or supplied power cord set. Whenever it is likely that the protection has been impaired, the instrument must be made inoperative and be secured against any unintended operation.

If this instrument is to be energized via an autotransformer for voltage reduction, make sure the common terminal is connected to the earthed pole of the power source.

LINE VOLTAGE SELECTION

CAUTION

BEFORE CONNECTING THIS INSTRUMENT to line (Mains) voltage, be sure the line voltage switch is set correctly and that the proper fuse is installed.

If the line fuse burns out, do not replace it until the cause for failure has been determined and repaired by a qualified service person. Replacing this fuse in a damaged instrument can cause additional damage.

AC POWER CABLE

WARNING

BEFORE CONNECTING THIS INSTRUMENT, the protective earth terminal of the instrument must be connected to the protective conductor of the (Mains) power cord. The Mains plug must be inserted in a socket outlet provided with a protective earth contact. The protective action must not be negated by the use of an extension cord (power cable) without a protective conductor (grounding). Grounding one conductor of a two conductor outlet does not provide an instrument ground.

OPERATOR'S MAINTENANCE

The only instrument maintenance an operator needs to perform is to occasionally clean the display screen and the front panel keyboard. When cleaning the 1630A/D/G, caution must be used with which cleaning agents are used. Use a mild soap and water solution. If a harsh soap or solvent is used, the water-base paint finish will be damaged.

CAUTION

Use care when cleaning the front panel keyboard. Water can damage the keyboard circuitry if it seeps under the keys.

CAUTION

Do not use chemical cleaning agents or abrasive cleaners that may damage the plastics in this instrument. Recommended cleaning agents are isopropyl alcohol, kelite (1 part kelite, 20 parts water), or a solution of 1% mild detergent and 99% water.

SITE SELECTION

Place the logic analyzer on a clean workspace which has adequate ventilation.

REAR PANEL ADDRESS SWITCH

The dip (dual-inline-package) switch on the rear panel of the logic analyzer is used to configure the analyzer for operation on the HP-IB and/or HP-IL interface buses, and to execute the self-test routine. The first five switches set the address of the analyzer for HP-IB operation. Switch six executes the analyzer self-test when set to "1". The positions of switches 7 and 8 determine the analyzer configuration on the HP-IB/HP-IL interface buses.

1. When operating the analyzer as part of a system, set switches one through five to select the system address for your analyzer. Set switches seven and eight to select the desired system controller.
2. If operating the analyzer in a stand-alone (no external controller) configuration, with or without an external printer, set switches seven and eight to select the TALK ONLY mode (both switches to "0").
3. Set switch six to "0". Switch six is set to "1" only during the self-test.

NOTE

A switch is set to "1" when its toggle lever is up, and set to "0" when its toggle lever is down.

REAR PANEL BNC CONNECTORS

The rear-panel BNC labeled ACCESSORY POWER provides 5 volts (1 ampere maximum) for operating an external HP preprocessor interface module.

The rear-panel BNC labeled PORT provides a TTL control signal whose characteristics are selectable in the SYSTEM [Peripherals] menu for control of external measurement instruments and equipment.

CONNECTING OPERATING POWER

WARNING

Before switching the instrument on, connect all protective earth terminals, extension cords, auto-transformers, and devices to a protective earth grounded socket. Any interruption of protective earth grounding is a potential shock hazard that could result in personal injury or death.

Use only the recommended fuse with the required current rating. Do not use repaired fuses or short-circuited fuseholders. To do so could cause severe shock or fire hazard.

CAUTION

Before switching the instrument power switch to the on position, the line selection switch on the rear panel must be set to the voltage power source, or damage to the instrument may result.

Excessive input voltage will damage the input attenuators. Observe the maximum input rating described in table 1-1.

APPLYING OPERATING POWER

Follow these steps before applying line power to the instrument.

On rear panel:

1. Check VOLTAGE SELECTOR switch for correct setting.
2. Plug in supplied power cable.

Press front panel LINE to 1 (down position).

SELF-TEST

The analyzer has a self test routine contained in the analyzer ROM. The self-test of the 1630A/D checks RAM, ROM, and functioning of the measurement channels within the analyzer. The self-test of the 1630G makes the same checks and also checks the HP-IB port and internal storage.

The self-test provides troubleshooting information if the analyzer is not functioning in the normal manner. If an error is displayed during the self-test, or if the self-test does not occur, contact your nearest Hewlett-Packard Sales and Service Office.

NOTE

Before initiating the self-test, disconnect any connected pods from the target system and the HP-IB cable from the rear panel of the analyzer.

To initiate the self-test, set switch 6 of the HP-IB address switch on the rear panel to "1" (switch lever up). Cycle the front panel LINE power, off and on, and the analyzer automatically executes the self-test.

1630A/D Self-Test

When the self-test of the 1630A/D has been successfully completed, the following messages are displayed on-screen:

```
PV Tests Pass
Reset Rear Panel Switch to XXXX XOXX to continue
```

If the self-test has not been successful, one or more of the following messages will appear on-screen:

```
Error in RAM
Error in ROM #n Expected XX was YY
Acq error
nn nn nn nn nn nn nn
```

1630G Self-Test

When the self-test of the 1630G has been successfully completed, the following messages appear on-screen:

```
RAM ok
ROM ok
Acquisition ok
internal storage ok
HP-IB ok
```

```
Toggle HP-IB address MSB to reset internal storage
Reset rear panel switches to XXXX XOXX to continue
```

If an error occurs in RAM or ROM, the self-test is discontinued. When the self-test is not successful, the following messages may appear in place of any one or more of the previous messages:

Error in RAM

Error in ROM #(0-7) Expected XX was XY

Acq error:

nn nn nn nn nn nn nn nn nn

Internal checksum error

HP-IB failed loopback test

RESETTING INTERNAL STORAGE

When an error is detected in the checksum of internal storage during the self-test, the analyzer automatically resets internal storage. While resetting internal storage, the message "WAIT Resetting internal storage" is displayed on-screen. If the reset is successful, the message "Internal storage reset successful" is displayed on-screen. If the reset has not been successful, the message "Reset failed, internal storage has failed" is displayed.

To manually reset internal storage, toggle switch 1 of the HP-IB address switch. The message "WAIT Resetting internal storage" will appear on-screen while the reset is taking place. When the reset has been completed successfully, the message "Internal storage reset successful" is displayed. If the reset has not been successful, the message "Reset failed, internal storage has failed" is displayed on-screen. The analyzer may be used without the internal storage and the performance of the analyzer is not affected. When attempting to store information to the internal storage via the SYSTEM [Peripherals] menu, the analyzer will attempt to reset internal storage and the message "Internal storage failed power-up" will be displayed. Refer to Chapter 8 for more information about internal storage and the SYSTEM [Peripherals] menu. Inverse assemblers may not be loaded to the analyzer without internal storage.

POWER UP DISPLAY MESSAGES

When the analyzer is powered-up, it goes through a sequence of power-up routines and displays messages on the SYSTEM [Configuration] menu. The same power-up routines are performed after the self-test when the Self-Test switch on the HP-IB address switch has been returned to "0" (switch lever down).

NOTE

Reconnect HP-IB accessory instruments to rear panel HP-IB port before setting HP-IB switch 6 to "0".

During the power-up routine, the analyzer reads the HP-IB port and automatically assigns addresses to any accessories that may be connected to the HP-IB port. Addresses are assigned so duplication of addresses does not take place. Inverse assemblers and stored configurations are automatically re-loaded in the power-up sequence unless instructed otherwise in the SYSTEM [Peripherals] menu. The inverse assembler is loaded first, and then the stored configurations. The messages "Inverse assembler loaded" and "Configuration loaded" will be displayed in the lower left hand corner of the display when the internal storage checksum is correct. If on power-up, the internal storage checksum is in error, the message "Internal storage corrupt" is displayed in the lower left hand corner of the display. The analyzer will reset the internal storage and display "Internal storage reset successful" if it was able to reset. When not able to reset, the message "Internal storage failure" will be displayed. If an inverse assembler was stored it will be lost and the message "Inverse assembler lost" will be displayed whether the internal storage failed or was successfully reset.

CONNECTING ANALYZER TO TARGET SYSTEM

The analyzer can collect information through either HP Model 10269A/B Probe Interface or through direct connections from the general purpose probes. The procedures to be followed when making the connections will differ, depending upon which of the two types of connections are made. Refer to the procedures given in the following paragraphs for a description of how to make the connections for your particular equipment.

Connecting Analyzer Through Probe Interface

1. Install the preprocessor interface module in the probe interface.
2. Connect the ribbon cable from the probe interface (with preprocessor interface module installed) to the microprocessor in the target system.
3. Connect the probe pods from the analyzer to the appropriate pod sockets on the probe interface. Refer to the general purpose preprocessor operating note for appropriate pod connections.
4. Connect a BNC cable from the ACCESSORY POWER BNC on the analyzer rear panel to the ACCESSORY POWER (+5V) BNC connector on the probe interface.

NOTE

Some interface modules can draw up to 1 ampere from the 5-volt supply. If using coaxial cable, HP recommends using 4 feet, maximum, of type RG-58 coaxial cable to minimize voltage drop.

Connecting Probes Directly To Target System

1. Snap on the adapters for each of the general purpose probe pods.
2. Connect the line for each probe bit to monitor a node in the system under test. Leave extra lines unconnected. Do not connect signals with different threshold levels (some TTL and some ECL, for example) in the same probe pod.
3. Connect the ground probe from each pod to a ground point in the system under test.

Chapter 3. Front Panel Controls and Menu Map

Introduction	3-1
State Measurements	3-1
Timing Measurements	3-1
Interactive State/Timing Measurements	3-1

Chapter 3

Front Panel Controls and Menu Map

INTRODUCTION

This chapter consists of two figures to help familiarize the user with the operation of the 1630A/D/G Logic Analyzers. Figure 1 is the front panel keyboard of the 1630. The function of each key is described in the figure.

Figure 2 is a map of the available menus by selection with the INPUT or OUTPUT DISPLAYS keys at the top of the front panel keyboard. In general, making state, timing or interactive state and timing measurements may be accomplished by the following steps:

State Measurements

- Start with the SYSTEM Specification [Configuration] menu. (power-up or press SYSTEM)
- Configure for state analysis by selecting all channels for state measurements. (use ROLL keys)
- FORMAT the input data by assigning labels to groups of probe bits. (press FORMAT)
- Specify the TRACE to be collected by the state analyzer. (press TRACE)

Timing Measurements

- Start with the SYSTEM Specification [Configuration] menu. (power-up or press SYSTEM)
- Configure for timing analysis by selecting timing channels and glitch mode (on or off).
- FORMAT the input data by assigning labels. (press FORMAT)
- Specify the TRACE to be collected by the timing analyzer. (press TRACE)

Interactive State/Timing Measurements

- Start with the SYSTEM Specification [Configuration] menu. (power-up or press SYSTEM)
- Configure for interactive measurements by selecting a combination of state and timing channels.
- FORMAT the input data by assigning labels to both state and timing pods. (toggle FORMAT)
- Specify the TRACE to be collected by the timing and the state analyzers. (toggle TRACE)

Chapters 4 through 8 contain step-by-step procedures for setting up the specific menus.

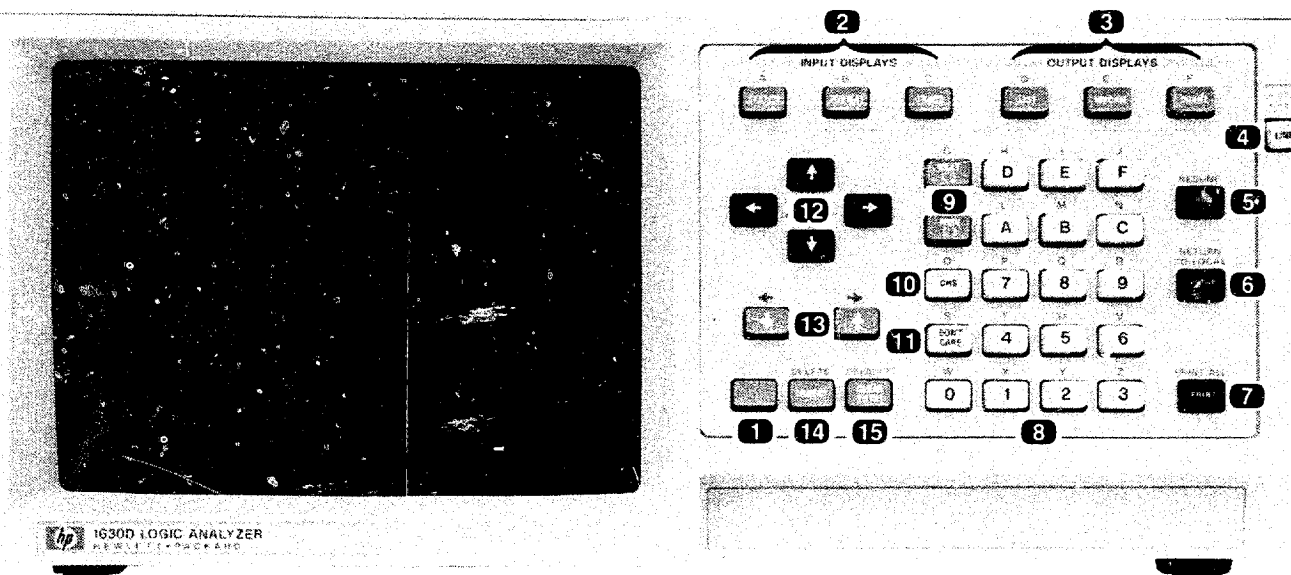

Blue key. This key activates the blue SHIFT function assigned to each keyboard key. A momentary press activates the SHIFT function for the next keystroke. The SHIFT function will continue as long as you keep the blue key pressed.

- 2 INPUT DISPLAYS. Three keys that select sets of 1630A/D/G menus. SYSTEM calls up menus that define the instrument configuration, set up secondary configurations and outputs for peripherals, and control tape or storage operations (when a tape or disc drive is connected and active). FORMAT has three menus that determine how data is collected and interpreted on the display. TRACE has a series of menus that specify the measurement mode and parameters for collecting data.
- 3 OUTPUT DISPLAYS. Three keys that select a state display (LIST), timing display (WFORM), or performance overview chart (CHART).
- 4 LINE. Turns on operating power.
- 5 RUN. Initiates a new measurement; RESUME continues an incomplete measurement that was halted by pressing the STOP key.
- 6 STOP. Terminates a measurement or print out; RETURN TO LOCAL overrides an HP-IB or HP-IL controller to return control of the analyzer to the keyboard.
- 7 PRINT. Commands the current display content to be printed on an HP-IB graphics printer; PRINT ALL prints the entire content of a displayed menu or, when a list is displayed, prints the entire trace list (including all off-screen information) from the on-screen information to the the end of trace memory.
- 8 Hex keyboard for data entry.
- 9 NEXT[] and PREV[] keys cycle through all the menu selections available for fields enclosed in brackets, [].
- 10 CHS. Used to change +/- signs when specifying memory locations in either direction from the trigger event, and when specifying polarities. This key will also print a dash when used in a text field.
- 11 DON'T CARE. enters an "X" in lieu of a number, to indicate "any value will serve". When used in a text field in lieu of a letter, enters a space.
- 12 CURSOR. These keys move the cursor from field to field in the menus. The blue SHIFT function allows these keys to rearrange the order of labels in the menus, and to move the cursor from pod to pod in the label lines of the FORMAT [Assignment] menu. The CURSOR keys can also move the configuration bar in the SYSTEM [Configuration] menu, and the "x" and "o" markers on the waveform and chart displays.
- 13 ROLL keys move timing displays left or right, state lists up or down, and the configuration bar in the SYSTEM [Configuration] menu.
- 14 INSERT/DELETE are used to add or delete fields and labels.
- 15 CLEAR ENTRY. This is the field eraser key; DEFAULT returns all fields in the displayed menu to their power-up conditions.

Figure 3-1. 1630 Front Panel Controls

INPUT/OUTPUT DISPLAYS MENU MAP

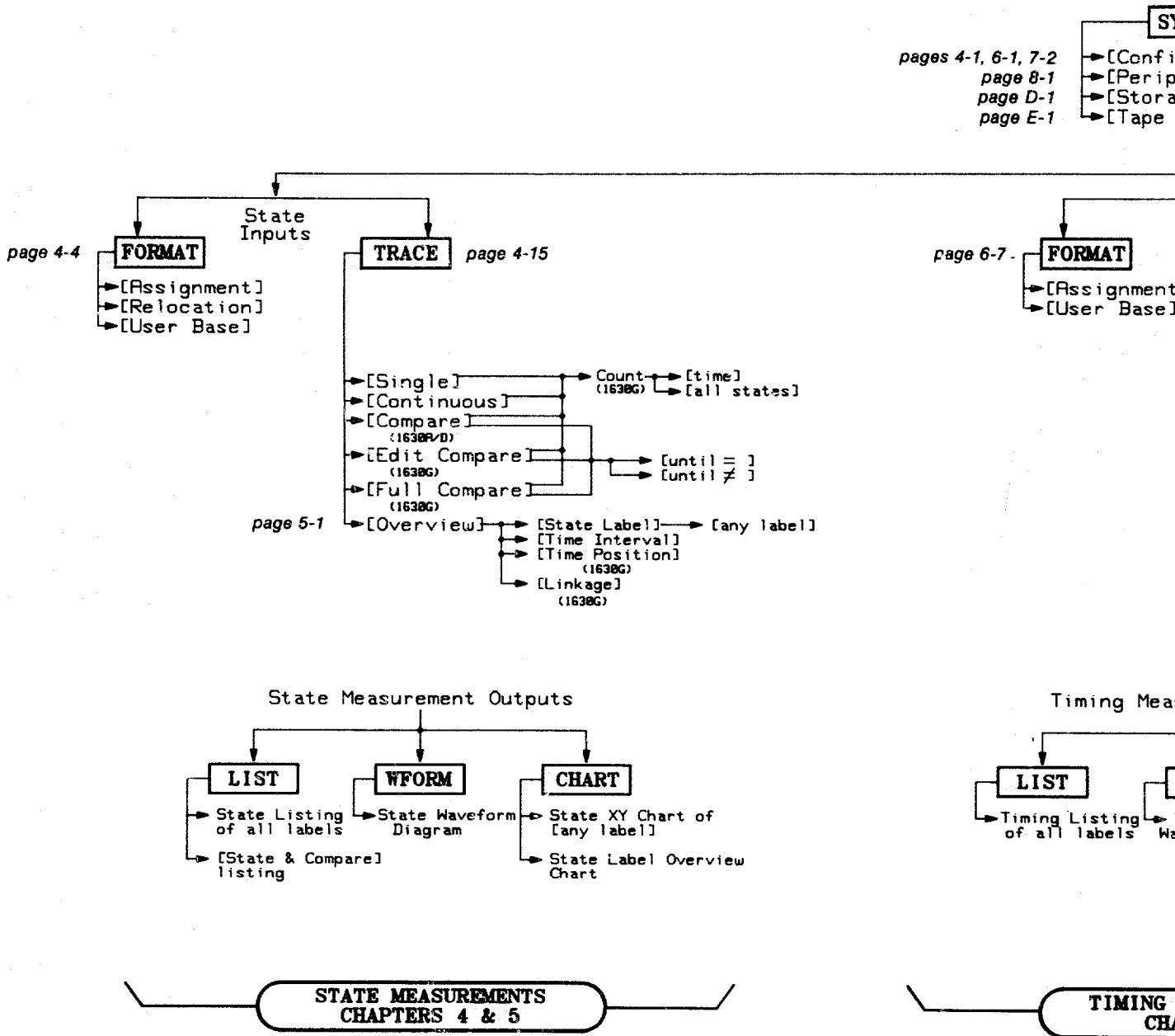

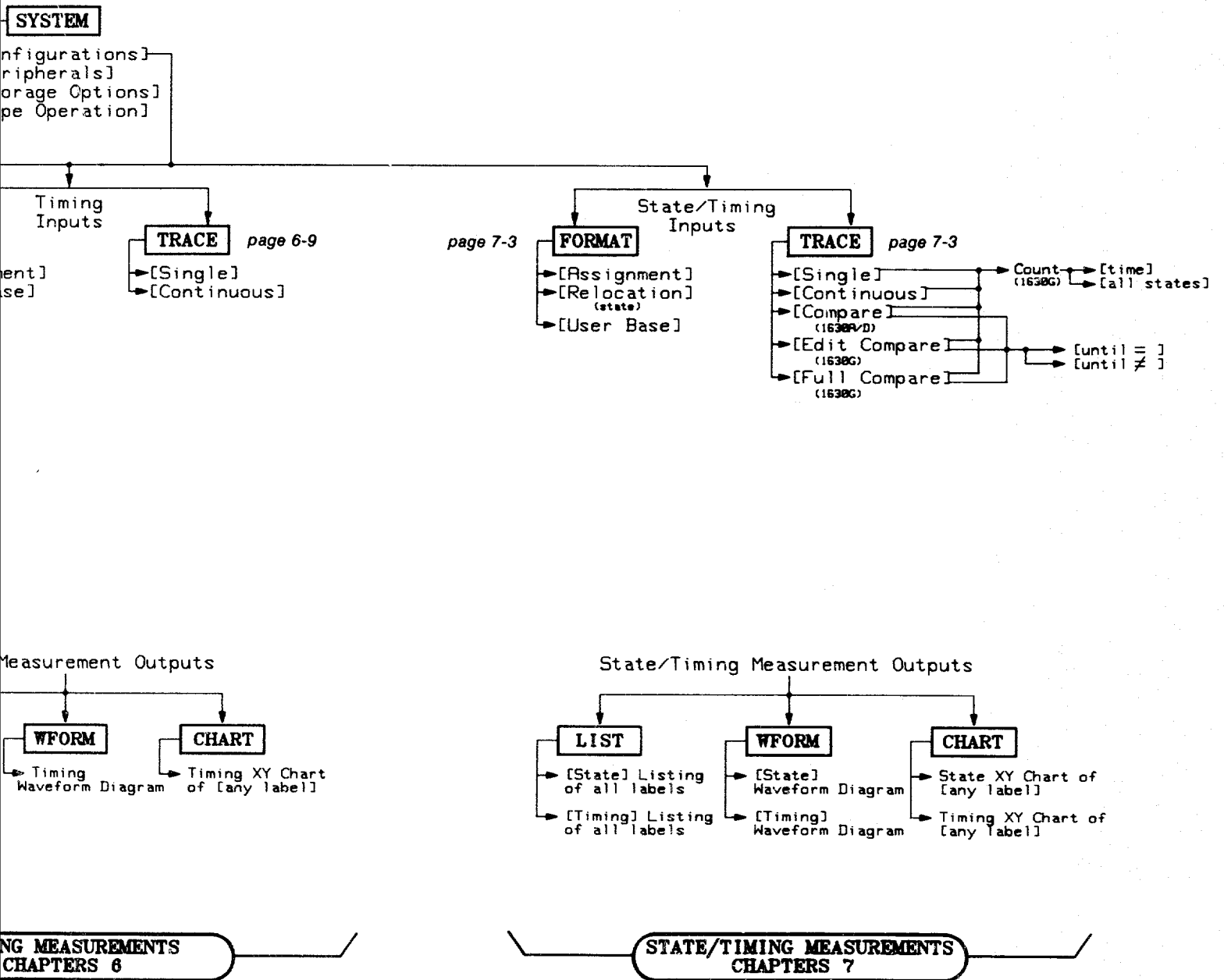

Figure 3-2.
Input/Output Displays Menu Map
3-3/(3-4 blank)

Chapter 4. State Measurements

Introduction	4-1
Capturing A State Trace	4-1
The State Format Specification	4-4
The State [Assignment] Format Specification	4-4
The State [Relocation] Format Specification	4-10
The State [User Base] Format Specification	4-13
Inverse Assemblers For The Logic Analyzer	4-15
The State Trace Specification	4-15
Resource Terms	4-19
Sequential Triggering	4-22
[Compare/Edit Compare/Full Compare] Trace Modes	4-27
The State Display	4-31
List Displays	4-31
Waveform Displays	4-33
XY Charts Of Label Activity	4-34

Chapter 4

State Measurements

INTRODUCTION

The 1630A/D/G Logic Analyzers are capable of capturing large quantities of data. To make this data useful, the incoming data needs to be formatted in an arrangement that is easily comprehensible. This is accomplished with the 1630A/D/G analyzers by grouping the incoming lines and labeling the groups for the typical connections for the address, data, status, and other lines of interest. Incoming data may be further identified by assigning user defined labels for conditions rather than the provided bases of hexadecimal, binary, or ASCII. Another type of user base may be assigned in which relocatable code is labeled by the user.

The next step in making the captured data useful is to edit the data before it is stored by the analyzer. Selective tracing techniques are used for recognizing and storing only qualified data. The 1630A/D/G Logic Analyzers provide a trace specification menu in which resource terms may be identified for selective tracing. Resource terms may be specified for simple triggering, sequence triggering, sequence restart, and store qualifying.

The target system used throughout this manual for examples is the HP Model 5036A Microprocessor Lab which contains an 8085 microprocessor. All traces shown in the figures are from the 5036A.

CAPTURING A STATE TRACE

1. Make all the required connections to the target system. Information for connecting the probes, directly or through an interface, is in chapter 2 of this manual.
2. Apply operating power to the logic analyzer and to the target system.

NOTE

When using a preprocessor, be sure to apply power to the analyzer first or the target system may not run.

The logic analyzer will execute power-up sequences and display the system menu in the default configuration. The 1630G will also display messages indicating what is being loaded from internal storage when it has been instructed to load internal configurations or an inverse assembler. See Power-up Display Messages in chapter 2 for more information on the power-up sequence and messages. The default system configuration assigns all channels to state measurement and none to timing measurements. Figures 4-1a and 4-1b are the default System Specification menus for the 1630D and 1630G. The 1630A default System Specification menu has eight less channels than the 1630D. Power-up display messages will appear on the display only when the analyzer is powered up.

3. Press RUN. The logic analyzer will execute a single trace and display a State Listing in hexadecimal. The measurement ensures the logic analyzer is connected to the target system and the target system is running. Figures 4-2a and 4-2b are examples of the state traces that will be displayed when collecting a free-run trace with the logic analyzer. The State Listing for the 1630G has more columns than the 1630A/D because it has more state channels and a counting function.

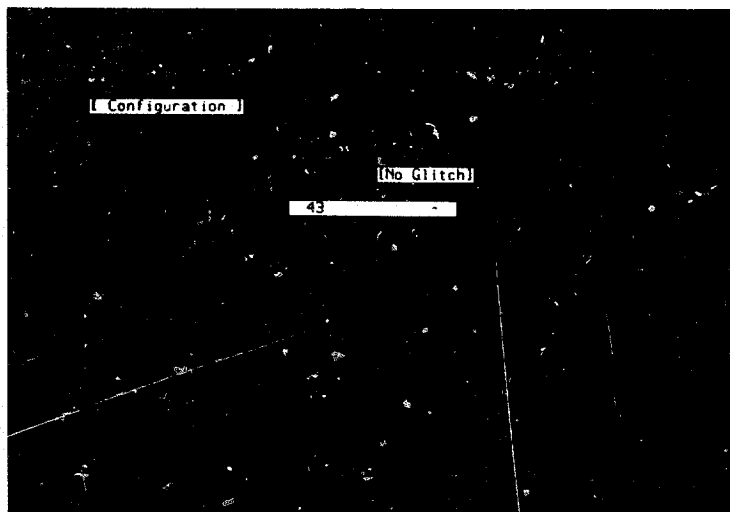

Figure 4-1a. 1630D Default System Specification Menu

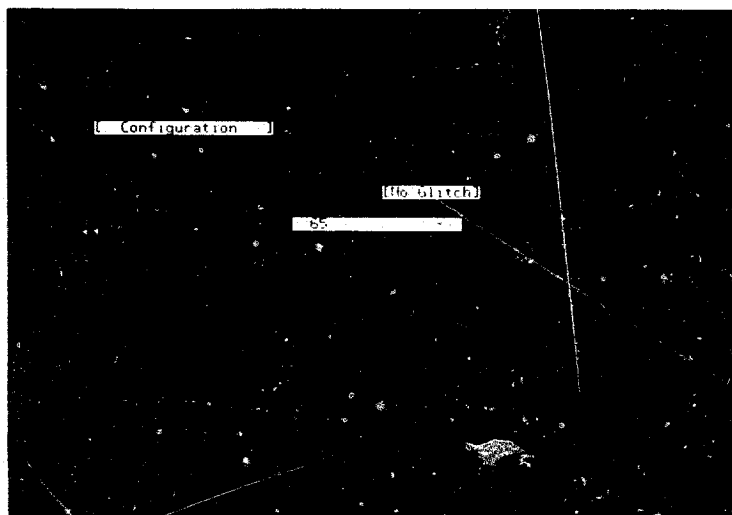

Figure 4-1b. 1630G Default System Specification Menu

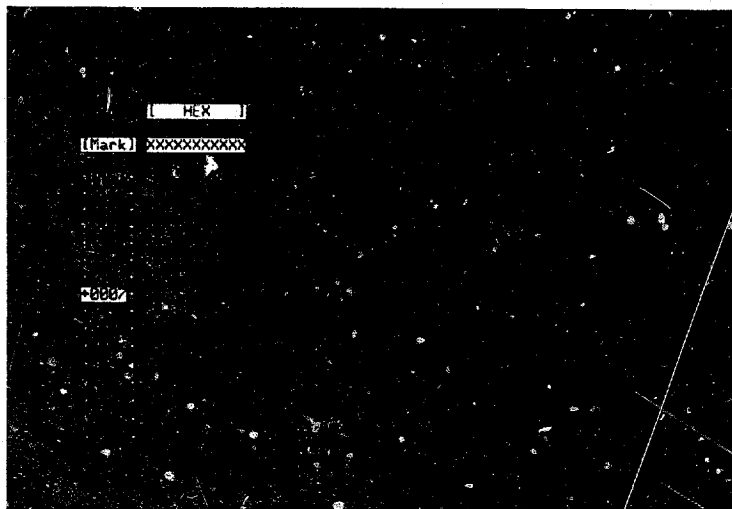

Figure 4-2a. Free-run State Trace Captured by the 1630A/D

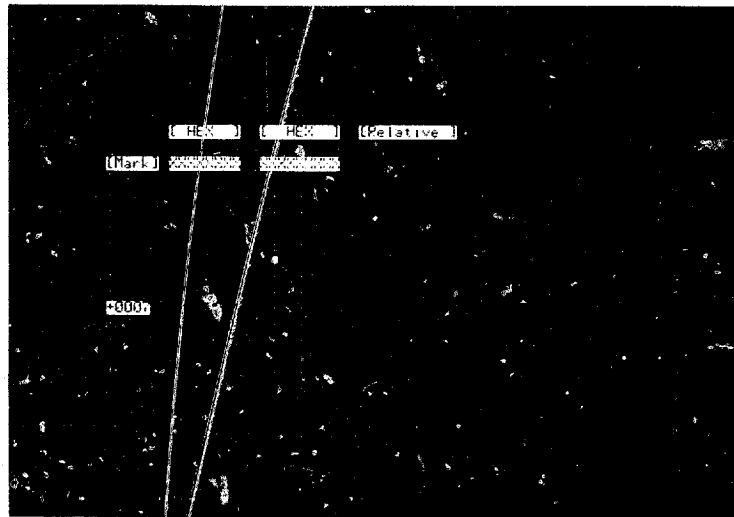

Figure 4-2b. Free-run State Trace Captured by the 1630G

NOTE

The figures in this manual apply directly to the display of the 1630G, unless titled otherwise. Therefore, when illustrating state listings the figures will appear different than the display of a 1630A/D. The 1630A/D does not have a time tagging function.

- In the State Listing, the blinking cursor is in the first column of the field next to Base. When the cursor is in a field enclosed in brackets, [], the NEXT[] and PREV[] keys are used to select available parameter choices for that field. Use the NEXT[] and PREV[] keys to cycle through the parameters available for number bases. Each time one of the two keys is pressed, the data in the column changes to the new number base and all columns are shifted to accommodate number bases requiring more characters. To return the columns to the original position, press the blue shift key in the lower left corner of the keyboard panel and the ROLL left or right key, as required.

NOTE

The blue shift key enters the alternate function/character shown in blue above each key. When the blue key is pressed the next key pressed will enter the blue alternate function/character. The blue key may be held down for repeated entries.

Use the blue key and the ROLL keys to move the entire display area left and right.

Use the blue shift key and LABEL arrow keys to move entire labels or, when the cursor is within a label field, the blue shift key and an arrow key may be used to move the cursor to the first position in the next field of the label.

NOTE

In the upper right hand corner of the display, arrows indicate the keys that may be used to control the display. The arrows indicate the CURSOR left, right, up, or down keys and the ROLL up or down keys.

THE STATE FORMAT SPECIFICATION

The State [Assignment] Format Specification

The logic analyzer must acquire data from the target system in exactly the same manner as the target system interprets the data. Therefore, the clock assignments and voltage thresholds utilized by the system must also be used by the logic analyzer. The logic analyzer must see the exact information that the target system sees. The type of information is specified in the analyzer with the State [Assignment] Format Specification menu. The State [Assignment] Format Specification menu is also used to group incoming channels and assign names (labels) to the groups. Assigning labels to groups (such as the address, data and status channels) makes the data displayed on the logic analyzer much easier for the user to interpret and analyze.

Figures 4-3a and 4-3b are the default State Format Specification menus that are displayed on the 1630A/D and 1630G when the FORMAT key is pressed. When the analyzer runs a trace, only probe channels assigned to a label are displayed in the listing. All channels on the 1630A/D are defaulted to label "A". The 1630G assigns channels from pods 5, 6, and 7 to label "A0" and channels from pods 1 through 3 to label "A1". All probe channels are initially assigned to a label so when a trace is listed, all channels are included in the listing. All channels not connected are indicated by a zero in the State Listing.

NOTE

The arrows at the left and right of the label fields in figure 4-3b indicate there are more bits assigned to the left of label A0 and to the right of label A1.

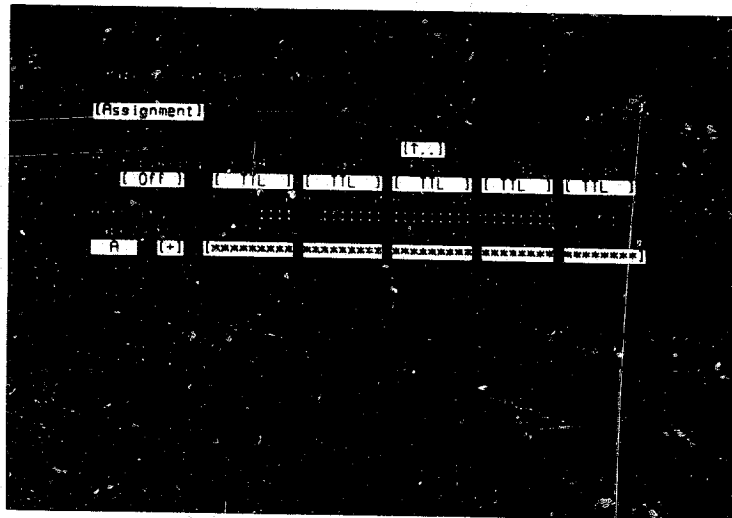

Figure 4-3a. 1630A/D Default State Format Specification Menu

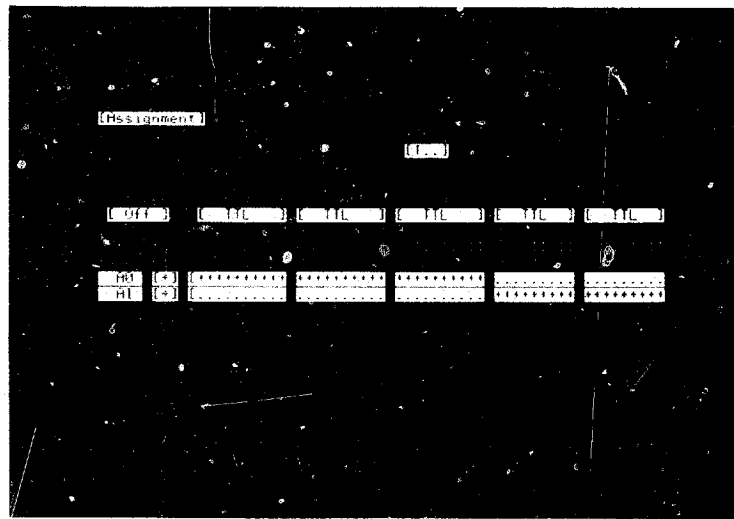

Figure 4-3b. 1630G Default State Format Specification Menu

CLOCK ASSIGNMENTS

The logic analyzer must recognize data on the same clock edge as the target system when taking state measurements. Three OR'ed clocks are available in the State [Assignment] Format Specification. The default clock assignment specifies to the analyzer to collect data on the positive edge of the J clock. Other clock specifications may be made by moving the cursor to the OR'ed clock field on the assignment menu and using the NEXT[] or PREV[] keys to select different clocks and edges.

MULTIPLEX ASSIGNMENT

Some target systems may use multiplexing in which certain signal lines are used for different information at different times. In the target system used for the examples in this manual, the data bits and eight lower address bits are multiplexed on the same pins of the microprocessor. The logic analyzer can demultiplex these lines so the data and address will be listed in separate columns in the state listing. To set the multiplexing mode on, move the cursor to the field under Multiplex (Multiplexing on 1630 A/D) in the State [Assignment] Format Specification and press the NEXT[] or PREV[] key. The multiplex choices are displayed in ratios that indicate the number of channels to be processed by the slave/master clocks. The slave clock moves information to a holding register and the master clock puts both sets of information into the logic analyzer memory. When multiplexing is on, edges for the master and slave clock are automatically assigned. To change clock assignments, move the cursor to the clock field and use the NEXT[] or PREV[] keys to select different clocks and edges.

For the target system used in examples for this manual, the multiplex field is set to [27/16] on the 1630A/D and to [27/38] on the 1630G. These are the typical settings for 8-bit microprocessors that multiplex data and address lines in the same manner as the 8085. For 16-bit microprocessors that utilize multiplexed lines, demultiplexing is usually set at 18 channels for the slave clock instead of 27.

THRESHOLD ASSIGNMENTS

Input threshold levels are selectable for each pod. The threshold is selected by moving the cursor into the field under an individual pod and selecting TTL, ECL, or absolute voltages between -9.9V and +9.9V. The threshold level determines whether the incoming voltage will be recorded as a logic 1 (if above the threshold) or a logic 0 (if below the threshold level).

NOTE

All probe connections within a pod are assigned the same threshold level.

ACTIVITY LINE

The activity line under each pod in the State [Assignment] Format Specification indicates the channels on which voltage changes are taking place. A double-ended arrow indicates an active channel (> 400 Hz) and a single bar indicates a steady state, either high or low.

LABEL ASSIGNMENTS AND POLARITY

1. Move the cursor to the label column in the State [Assignment] Format Specification menu. A message will appear on the display screen indicating a new label may be added. Press INSERT and a new label field will be added. Labels are entered with numeric keys and/or the blue shift key and the alphabetic characters. Up to eight labels may be assigned and each label may consist of up to five characters. (Labels are deleted by pressing the blue shift key and and DELETE when the cursor is anywhere on the line of the label to be deleted.)
2. Add the label ADDR to the label column in the new field. Notice the field to the right of the label field. By using the NEXT[] or PREV[] key, + or - may be selected to indicate whether a voltage above the threshold voltage is to be displayed as a 1 or 0. A + in this field indicates voltages above the threshold are 1 and voltages below are 0. Choosing - gives the opposite display.

NOTE

Polarity choice does not affect the waveform display.

3. Press and hold the CURSOR right arrow to move the cursor across the label field to bit 6 of pod 3. This is the MSB (most significant bit) of the address channels connected to the analyzer.

NOTE

Pod2 will be off-screen in the 1630G format menu, use the ROLL keys for bit-by-bit shifting of the pods, or the blue shift key and the ROLL keys to shift entire pod displays.

4. Press either NEXT[] or PREV[] key sixteen times, or hold either key down, until sixteen asterisks appear in the entries beneath Pod3 and Pod2. The asterisks assign the corresponding probe bits to the label designated ADDR.
5. Press LIST. The bits that are assigned to the label ADDR are now listed in a new label column, ADDR, in the State Listing. Figure 4-4 is the state listing with the address bits assigned to the label ADDR.

NOTE

When a trace is run, data is acquired on all connected channels (assigned to a label or not). The format may be modified and new information may be displayed without taking a new trace. Acquired data may be manipulated by changing the format menu.

6. Press FORMAT and add labels for DATA lines and STAT (status) lines the same way the ADDR label was added. Assign the appropriate bits (as connected in chapter 2) to the added labels.

NOTE

The bits assigned to labels need not be physically adjacent. Bit 2 in Pod1 may be combined with bit 5 in Pod3 for assignment of a single label consisting of the two probe channels.

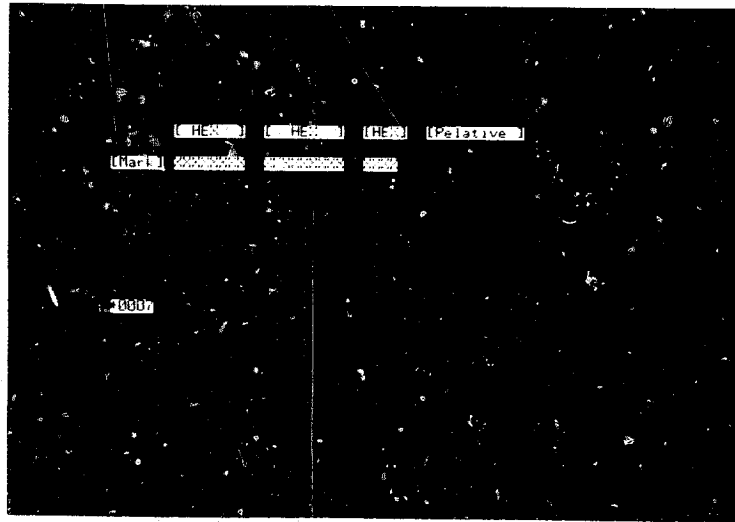

Figure 4-4. 1630G State Listing Including the ADDR Label

- 7 Move the cursor to the label A on the 1630A/D, or to labels A0 and A1 on the 1630G, with the CURSOR arrow keys. Press the blue shift key and DELETE to remove labels A, A0, and A1 from the State Format Specification. Figures 4-5a and 4-5b are the State [Assignment] Format Specifications for the 1630A/D and 1630G with the appropriate probe bits assigned to labels ADDR, DATA, and STAT.

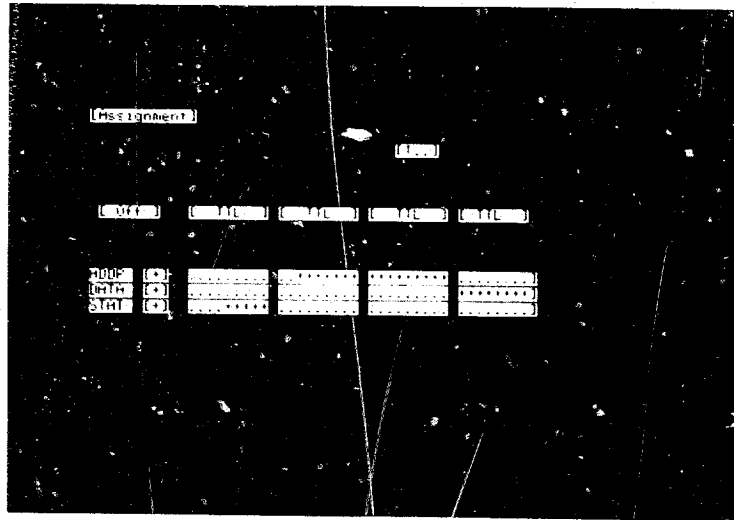

Figure 4-5a. 1630A/D State [Assignment] Format Specification Menu

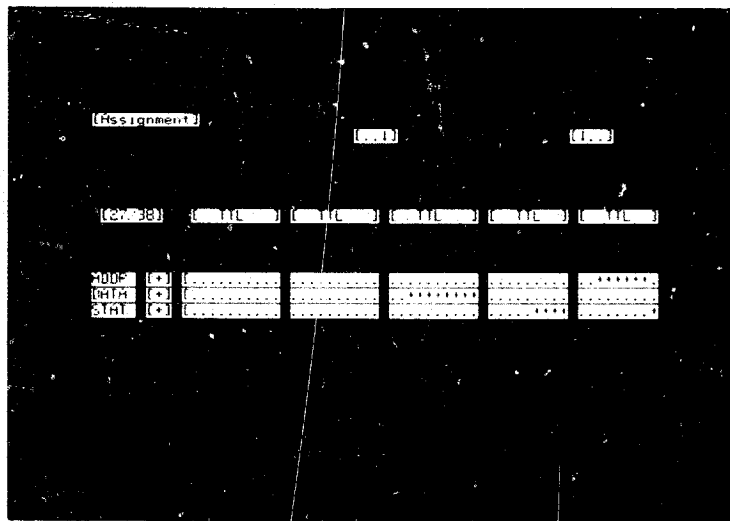

Figure 4-5b. 1630G State [Assignment] Format Specification Menu

NOTE

The format specification in figure 4-5b is for the target system, with a 8085 microprocessor, being used for the examples in this manual. All assignments pertain to the 8085 including the clock and multiplex assignments.

- 8. Press LIST and see that all assigned labels now appear in the state listing and the default labels (A, A0, and A1) are no longer displayed, as in figures 4-6a and 4-6b. The State Listing makes more sense now and the list is easier to analyze. The number base for any label may be changed by moving the cursor to the base field under the label and using the NEXT[] or PREV[] keys to select different bases.

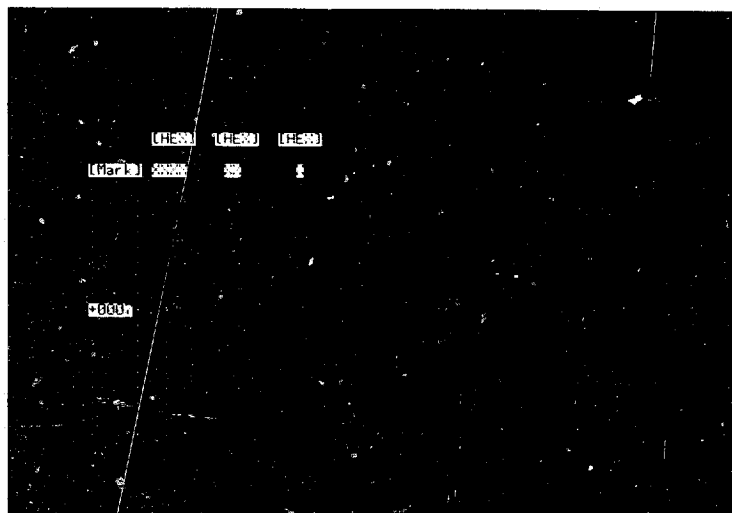

Figure 4-6a. 1630A/D State Listing for ADDR, DATA, and STAT Labels

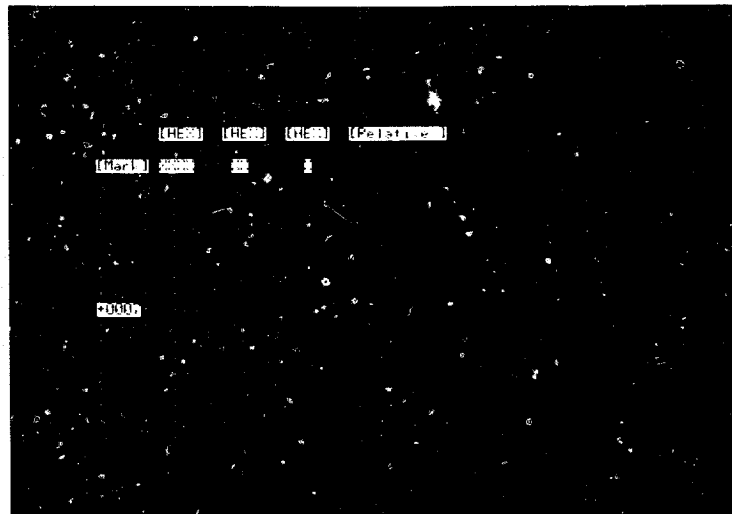

Figure 4-6b. 1630G State Listing for ADDR, DATA, and STAT Labels

NOTE

The differences in the State Listings of figures 4-6a and 4-6b are due to the format specifications in figures 4-5a and 4-5b. The data in the listing of figure 4-6b is the correct data for the 8085 because demultiplexing of the data and address lines has been specified.

9. Channels are not restricted to a single label, they may be assigned to two or more label groups. Press FORMAT and add a new label, MIX, as in figure 4-7. Assign all the STAT bits, the last four ADDR bits and the first four DATA bits to the label MIX. Steps 2 through 6 describe how to add a new label and assign bits.

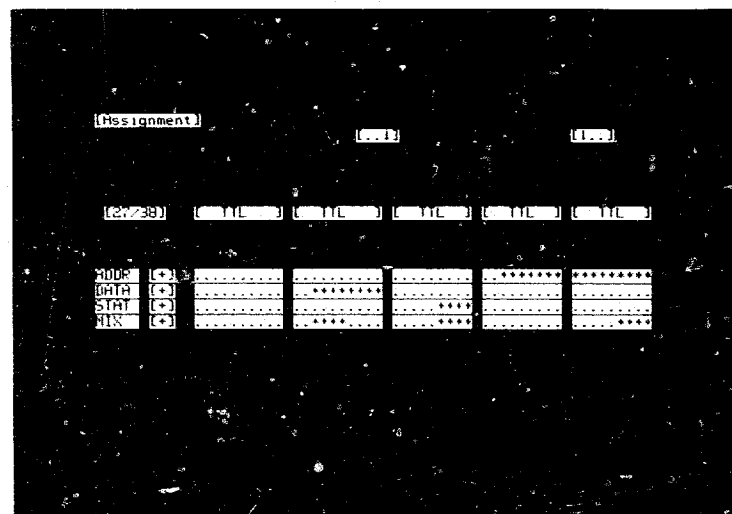

Figure 4-7. State Assignment with Bits Assigned to Multiple Labels

10. Return to the State Listing by pressing the LIST output display key. The label MIX has been added to the display as shown in figure 4-8. The characters under the MIX label are the MSB (most significant bit) of DATA, STAT, and the LSB (least significant bit) of ADDR.



Figure 4-8. State Listing With Bits Assigned to Multiple Labels

- The MIX label has no purpose at this time, but assigning bits to more than one label can be helpful in troubleshooting. To remove the label, return to the State [Assignment] Format Specification menu by pressing FORMAT. Move the cursor anywhere on the MIX label line. Delete the entire line by pressing the blue shift key and DELETE.

The State [Relocation] Format Specification

The State [Assignment] Format Specification provides a means to group the incoming channels to the logic analyzer into meaningful labels to make reading the display easier. These labels may be further grouped and labeled to make the display even easier to analyze. In the following steps, the address ranges in the label designated ADDR in the State [Assignment] Format Specification are grouped and given module names.

The target system has four operations that we want to label: a keyboard checking routine, a timing routine, stack operation, and OUT addresses for scan and display. Each routine has a starting address and uses a known number of addresses, however, there is unknown code in the addresses between the routines to be labeled. Table 4-1 is a listing of the routine modules with starting addresses and the known amount of addresses used for each module.

Table 4-1. Address Map for Relocation Example

Named Module	Starting Address	Addresses Used
KEYBD	01D0	0012H
TIME	0429	001EH
STACK	0BB0H	0050H
SCAN	2828H	0001H
DSPLY	3838H	0001H

- Press FORMAT. The State [Assignment] Specification menu will be displayed. Change [Assignment] to [Relocation] by using the NEXT[] or PREV[] key. Relocation applies to any label previously defined in the State [Assignment] Specification.
- Figure 4-9 is the default State [Relocation] Format Specification menu. Since ADDR is the first label assigned in the [Assignment] specification, it is shown in the label field. Move the cursor to the label field and cycle through the labels available for relocation by using the NEXT[] or PREV[] key.

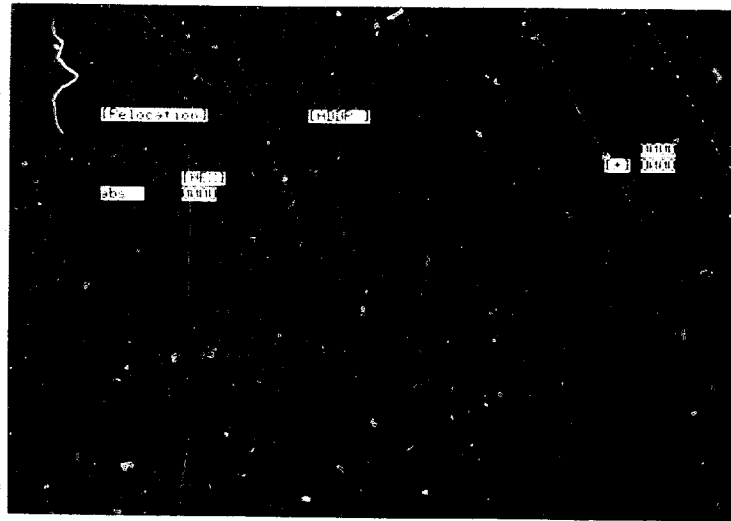

Figure 4-9. Default State [Relocation] Format Specification Menu

3. Select [ADDR] for the label field. Only one label at a time may be used in the [Relocation] mode. By naming ranges in the [ADDR] label, routines that are executing may be identified in the State Listing.
4. Move the cursor to the abs 0000 field in the Module Name column. Enter the module name KEYBD and the starting address value in the next column.
 - a. Move the cursor to the first field under Calculator and enter the starting address for the module name.
 - b. Move the cursor to the middle field of Calculator and enter the number of addresses used for the module.
 - c. The last number in the Calculator field shows the first address of unnamed code after the module. Use this address as the starting address of the next module name.
5. There is code between the modules KEYBD and TIME which can be labeled module A to differentiate it from the KEYBD and TIME modules. Move the cursor to the Module Name column and add module A. Use the address determined by the calculator for the starting address.
6. Continue to INSERT the rest of the code modules until the State [Relocation] Format Specification looks like figure 4-10.
7. Press LIST. Change the base field for ADDR with the NEXT[] key to [REL+HEX]. Now the state list for the ADDR label includes the relocatable module name and the offset addresses referenced from the beginning of the module (in hexadecimal base). The new state listing is shown in figure 4-11. In figure 4-11 the trigger is now TIME+0010 which means the trigger is located 10 addresses into the TIME module.



Figure 4-10. State [Relocation] Format Specification With Assigned Modules

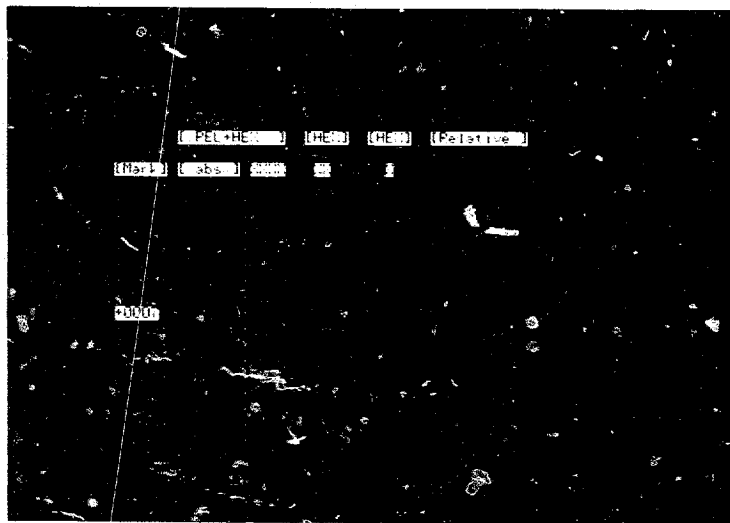

Figure 4-11. State Listing Using Relocation Values

8. A comparison of the relocatable code modules and the absolute hexadecimal values, two columns of the same states, may be made
 - a. Press FORMAT twice to return to the State [Assignment] Format Specification menu.
 - b. INSERT a new label, ADDR1, and assign all address probe bits to the label.
 - c. Press LIST and both lists for the address bits will be displayed in the state listing as in figure 4-12.

NOTE

For easy comparison of lists, the ADDR1 list may be moved to the right of ADDR. Move the cursor to the ADDR1 label field and press the blue shift key and then the LABEL CURSOR left key.

9. Similar relocation ranges and names may be assigned to the other labels from the State [Assignment] Format Specification.

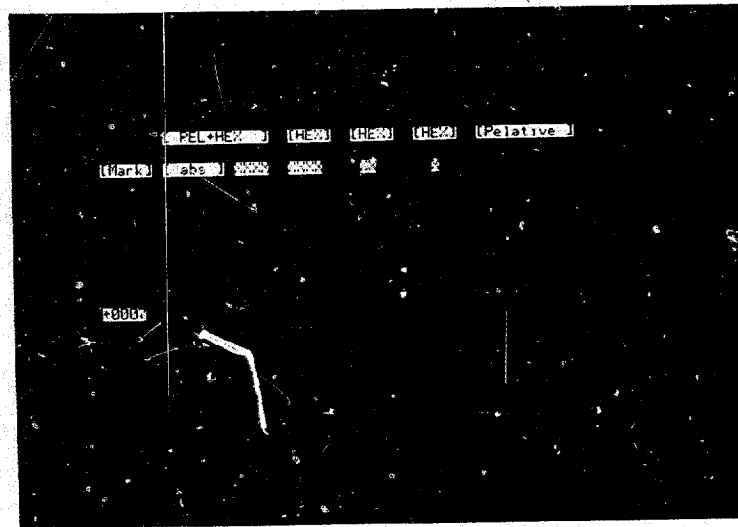

Figure 4-12. State Listing With Relocation and Absolute Value Lists

The State [User Base] Format Specification

The State [User Base] Format Specification is used to assign user defined names to conditions on control and status lines. The user base names may then be displayed on the state listing in place of the numeric values to make the data on the display easier to interpret.

Only labels with four probe bits or less may be assigned user base names. The maximum amount of user base conditions for each label is sixteen. All labels that have been assigned in the State [Assignment] Format Specification may have user base names assigned providing four or less bits are assigned to each label. The user base names may be any of 1 to 5 alphanumeric characters.

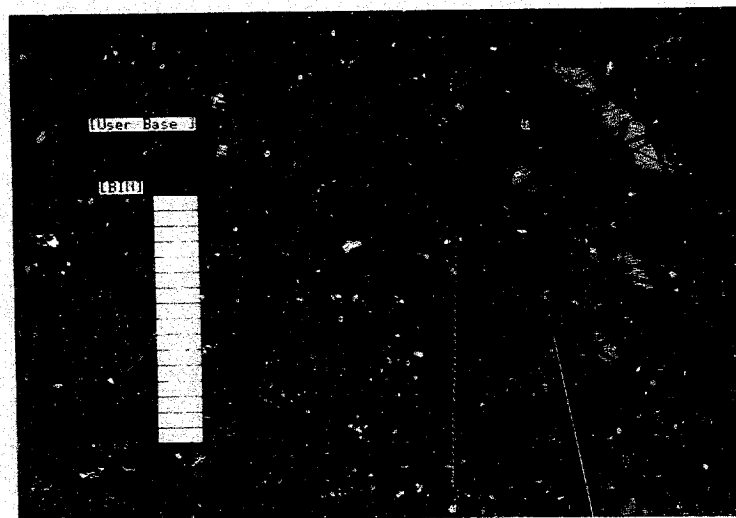

Figure 4-13. State [User Base] Format Specification Menu

1. Press FORMAT and select [User Base] with NEXT[] or PREV[] key. STAT is the label from the assignment specification with four or fewer probe bits assigned to it and is automatically displayed in the State [User Base] Format Specification menu, shown in figure 4-13. Since there are four bits assigned to the label, STAT, there are sixteen possible conditions that may exist in the STAT label. When the 8085 is executing instructions, there are six basic types of operations that are performed. The six operations, the STAT label binary conditions, and the user base names to be assigned are listed in table 4-2.

Table 4-2. User Base Names for STAT Label

8085A Operation	User Base Name	Binary Value
Read from memory	MEMRD	0001
Write to memory	MEMWR	0010
Read from input	IO-RD	1001
Write to output	IO-WR	1010
Opcode fetch	OPFCH	0011
Interrupt acknowledge(transferring control to another location)	INTAK	1011

- Assign the STAT label codes to the appropriate conditions in the State [User Base] Format Specification as shown in figure 4-14.

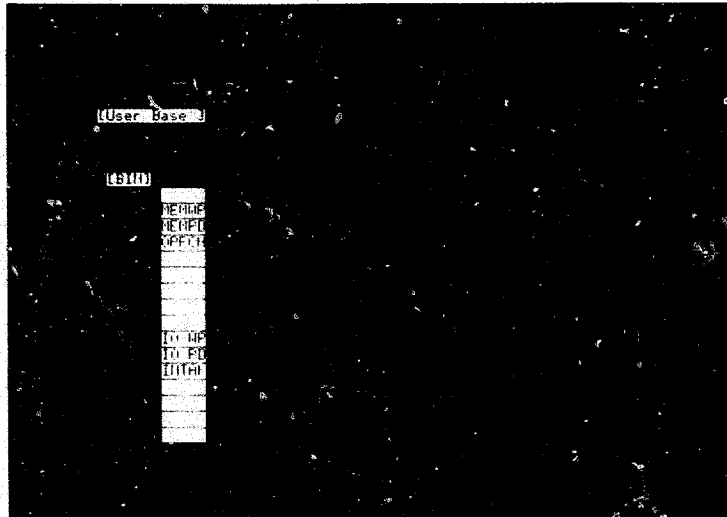

Figure 4-14. User Base Specification With Assigned Conditions to STAT Label

- Press LIST. Move the cursor to the base field under the STAT listing and press the NEXT[] key twice. The STAT listing is now in the user base names, as in figure 4-15, instead of numeric values.



Figure 4-15. State Listing With User Base Names in STAT List

INVERSE ASSEMBLERS FOR THE LOGIC ANALYZER

Inverse assemblers display the data from the target system on the logic analyzer screen in mnemonics similar to those of the microprocessor in the target system. Figure 4-16 is a state listing after the data from the system used for examples in this manual has been disassembled with the 8085 Inverse Assembler.

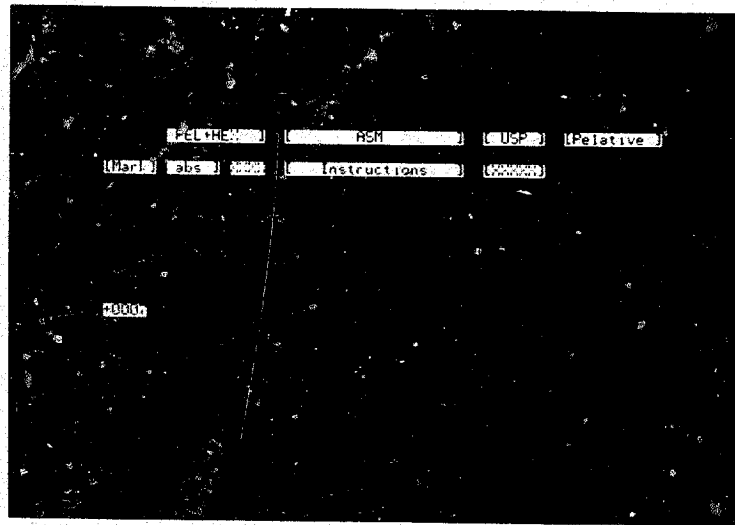

Figure 4-16. State Listing With Disassembled Data List

The inverse assembler file automatically sets up the State [Assignment] Format Specification and, in some inverse assemblers, the State [User Base] Format Specification.

When an inverse assembler has been loaded into internal storage, it is automatically reloaded upon power-up of the analyzer. The message "Inverse assembler loaded" will be displayed on the System [Configuration] Specification menu at power-up. Refer to Appendix D for information about loading and storing inverse assemblers.

Inverse assemblers are available, for many of the widely-used microprocessors, on minicassette or floppy disc. Refer to the appropriate appendix included in this manual for information on using an HP 82161A Digital Cassette Drive or an HP 9121D/S Flexible Disc Drive with the 1630A/D/G.

Most of the inverse assemblers available for use with the 1630A/D/G come in versions for HP 10269A/B Interface Module and for direct connection with individual probe connections. Refer to the operating note supplied with each inverse assembler for instructions about connections to the logic analyzer.

THE STATE TRACE SPECIFICATION

The Trace Specification determines where the logic analyzer starts a trace and what kind of information is collected in the trace. The logic analyzer can take [Single] or [Continuous] traces, [Compare] lists before storing a data, or perform [Overview] performance analysis measurements.

1. Press TRACE. The default State Trace Specification menu is shown in figure 4-17. In the default mode, the analyzer will take a single trace starting at the first occurrence of any state of the target system. All states thereafter will be stored until 1024 states are captured. The analyzer then automatically displays the stored trace.

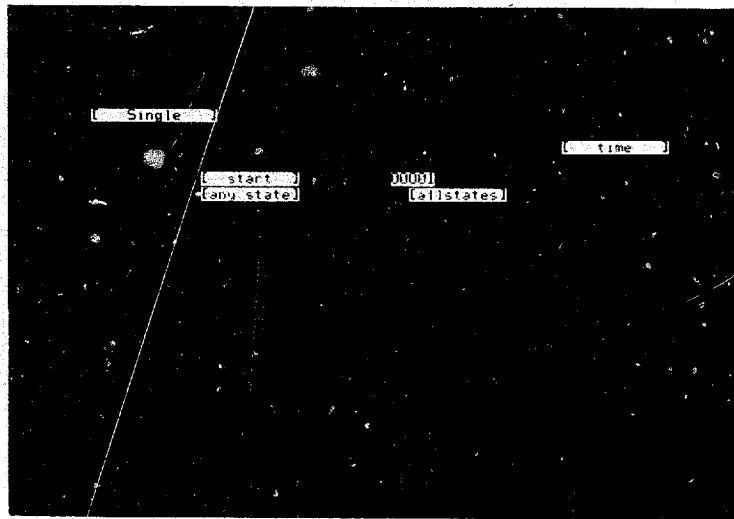

Figure 4-17. 1630G Default State Trace Specification Menu

2. Use the NEXT[] key and select the [Continuous] mode. Press RUN and the analyzer will perform series of trace measurements. At the completion of each measurement, the analyzer updates the display and starts a new trace measurement. The traces measurements continue until the STOP key is pressed. The time tagging list is not displayed during continuous traces, but is displayed when STOP is pressed and a single trace is taken.

NOTE

When STOP is pressed once, the analyzer completes and displays the measurement presently in progress. If STOP is pressed twice, the trace measurement is aborted and any states captured are displayed in the listing.

3. Press TRACE again and return to the [Single] trace mode by using the PREV[] key.

NOTE

Steps 4 and 5 apply only to the 1630G, the 1630A/D does not have the time tagging function.

4. Move the cursor to the Count field in the State Trace Specification menu. There are two choices available in the Count field for time tagging purposes. The default of the count function counts the time between each state in the state listing. This is displayed in the Time column of the state listing and may be seen in any of the previous figures of state listings of the 1630G. The 1630G can count states rather than time when the Count field specification is changed to [all states]. Figure 4-18 is a state listing when states are counted rather than execution time. States between and including each state in the state listing are counted.

The time tagging function has many useful applications such as: measuring time between calls to a routine, looking at the time between writing to an I/O port, or capturing the time a routine takes to execute.

5. Move the cursor to the States field in the State Listing of the 1630G. Use the NEXT[] or PREV[] key to see how the analyzer can display the States (or Time) list in absolute or relative values. Figure 4-19 is the State Listing with the State list in absolute values. In the [relative] mode, counting is relative to the previous state. In the absolute mode, counting is relative to the trigger.

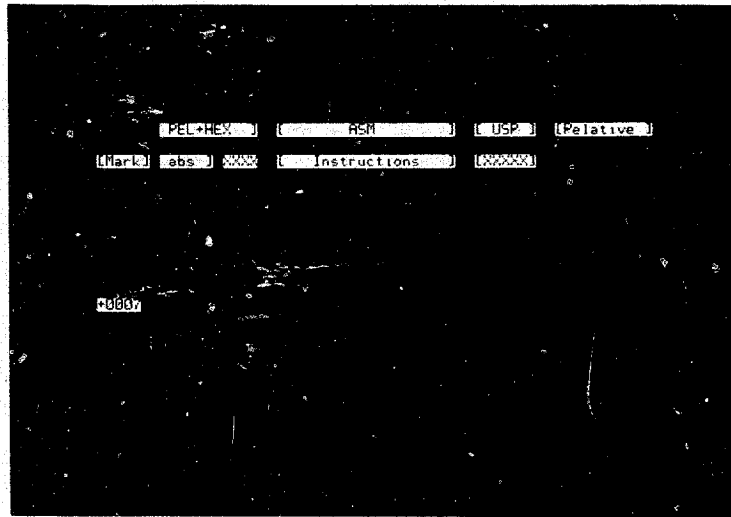

Figure 4-18. 1630G State Listing With Count States List

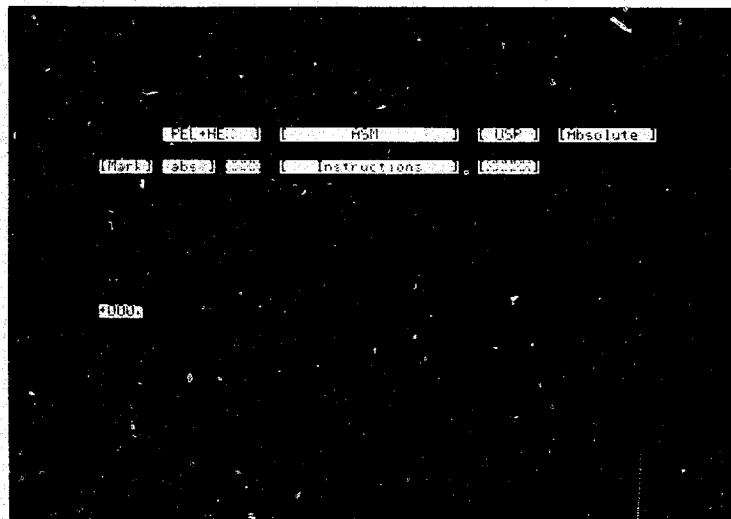

Figure 4-19. 1630G State Listing With States List in Absolute Values

6. When the analyzer captures a trace from the target system, the analyzer stores 1023 states, however sixteen states are displayed at one time. The list may be scrolled through by using the ROLL keys. Another way to quickly locate portions of the list is to move the cursor to the location in the State Listing marked by the inverse field and put a new value in the field. The list automatically changes to place the specified location in that position of the list. Typically, when a measurement is taken, only a few states or a particular event is of interest and it is not necessary to see the entire list. These states or events may be located by using the [Mark/Show] function of the analyzer.
7. Move the cursor to the field under ADDR at the right of the [Mark] field in the State Listing. Select an address in the list and place the value into this field. The asterisks that were beside each listing in the state list are now only at the locations that contain the address specified in the Mark field under the ADDR label, as in figure 4-20. If using relocatable module codes for display, use the NEXT[] or PREV[] key to select module name and enter the address to be marked with the front panel numerical keys.
8. Move the cursor back to the [Mark] field and change the field to [Show] with the NEXT[] or PREV[] key. Now only the states that contain the address specified are displayed, as in figure 4-21. The original trace is still preserved in memory, but has been temporarily edited.

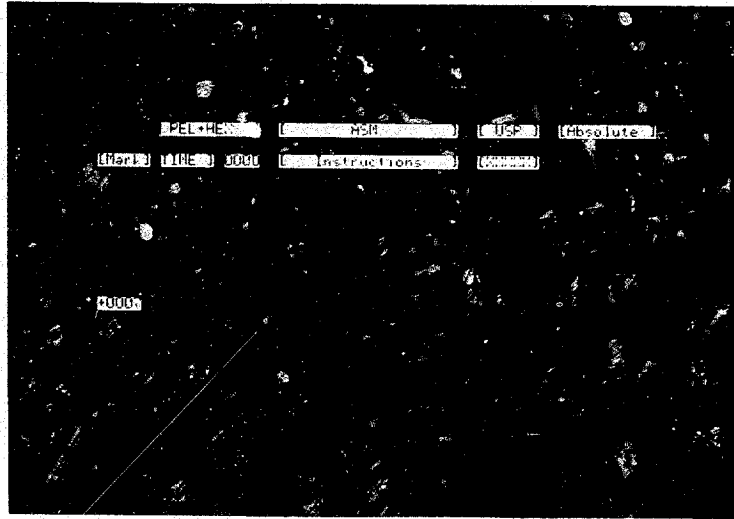

Figure 4-20. State Listing With Specific States Marked

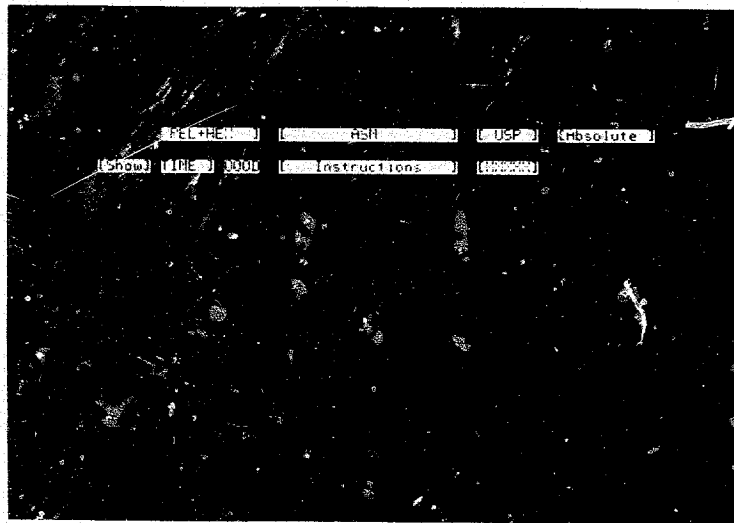

Figure 4-21. State Listing Showing Only a Specific State

9. The original list may be obtained by changing [Show] to [Mark] with the NEXT[] or PREV[] key and replacing the specified address under the ADDR label by X's with the DON'T CARE key.

NOTE

DON'T CARE triggering is useful for fault-finding in a system when part of the trigger word is unknown. For instance, if the trigger word is defined as 030X, (hexidecimal), the trace will trigger on any word from 0300 to 030F. The amount of words possible for triggering could be decreased further by specifying the trigger in binary base and defining only certain bits or one bit as DON'T CARE.

Resource Terms

When the logic analyzer takes state traces, activity is clocked into the analyzer by a clock from the target system. After 1024 consecutive states have been stored, the trace halts and is displayed on the analyzer screen. This method of taking traces is used in many cases, but usually a sequence of data or a particular event is of interest, making need for qualification of data before it is captured. Resource terms are used to define specific states for qualifying data before it is captured by the logic analyzer.

Resource terms may be defined with the logic analyzer, with which the analyzer compares incoming bit patterns. Only activity complying with terms specified in the State Trace Specification is stored by the analyzer. Four terms are available for use as resource terms: a, b, c, and d. The resource terms are user defined and may be assigned for simple triggering, sequence triggering, sequence restart, and/or store qualifying.

TRIGGER [START/CENTER/END] TRACE

When a resource term is defined as the trigger term to **[start]** the state trace, the analyzer waits until the trigger is found and then starts storing states in memory. After 1024 states have been stored, the trace is halted. The captured state list is then displayed on the analyzer screen with the trigger term at line location 0000 in the State Listing. Selective storing of states may be specified in the State Trace Specification by defining terms to be stored after the trigger is found.

When the resource term is defined as the trigger term to **[center]** the trace, the analyzer keeps track of the trigger term in the same manner as when a start trace term has been defined. After the trigger term is found and identified as the center of trace, states previous to the trigger term, the trigger term and the next 511 states are stored. The entire memory length of 1024 states may not always be listed in the State Listing. For instance, if the trigger term is found at the tenth state after RUN is pressed, nine states will be listed before the trigger in the listing (and labeled with a minus sign), the trigger (at line 0000), and 511 states after the trigger (labeled with a plus sign). The total listing will be 521 states long. Additional resource terms may be defined for selective storing.

The trace is stopped at the trigger term when the State Trace Specification defines the trigger term as the end of the trace. The analyzer displays the trigger term and up to 1024 states previous to the trigger depending on where the trigger is found after the RUN key is pressed. If the trigger term is found after 100 states, the State Listing will consist of 101 states.

Up to 59,999 occurrences of a state may be specified in the occurrence field of the State Trace Specification in order to pass loops in program activity that are well removed from the defined trigger term.

1. Press RUN and select one of the addresses from the ADDR column in the State Listing.
2. Press TRACE. Move the cursor to the **[any state]** field and select resource term **[a]** by pressing the NEXT[] key twice. When one or more resource terms have been selected, the four fields to define the terms are automatically added to the State Trace Specification menu as shown in figure 4-22.
3. Move the cursor to the first field under the ADDR label and type in the address selected in step 1. This specification tells the analyzer to start storing the trace in memory when it finds the selected address on the lines that have been labeled ADDR. The X's in the other fields indicate that any value on those lines will satisfy the trigger specification. Figure 4-23 is the trace specification to trigger on the first occurrence of a specified address.
4. Press RUN. The analyzer will monitor activity from the system under test until it finds the condition specified on the address lines. Then it captures that state in memory and all successive states until the memory is filled one time. The message "Trace Complete" will be displayed after a trace has been completed by the analyzer. The State Listing is shown in figure 4-24.

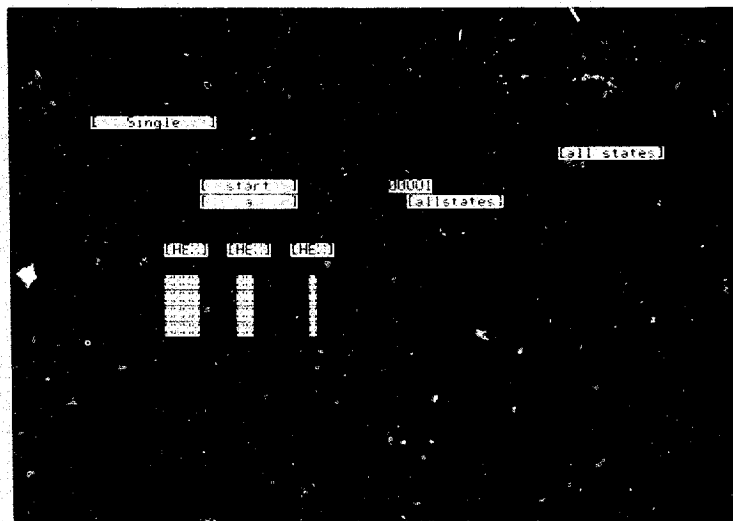

Figure 4-22. The State Trace Specification With Fields For Resource Terms

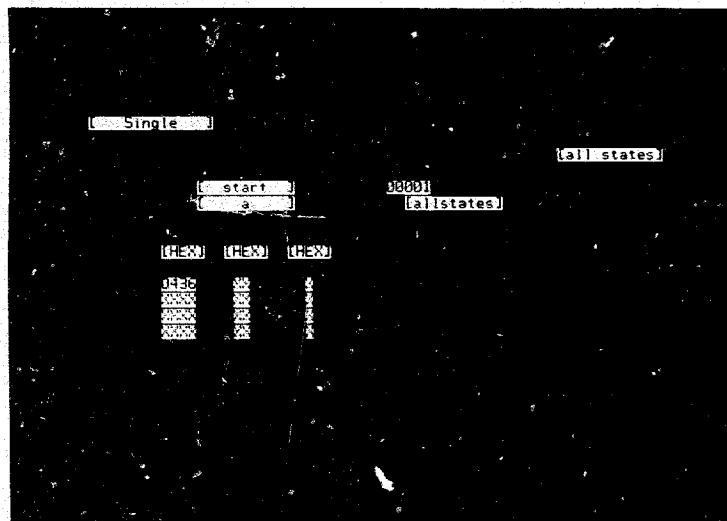

Figure 4-23. Specification of Trigger on First Occurrence of a Specific State

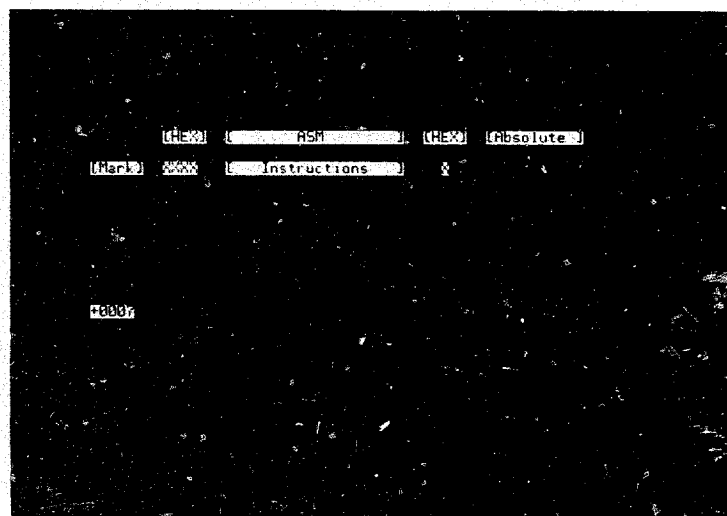

Figure 4-24. Trigger Starts Trace Listing

5. The trigger state specified in the trace specification is at location 0000 on the State Listing. Trigger was specified to be the start of the trace.
6. Press TRACE and move the cursor to the [start] field. Select [center] with the NEXT[] key to place the trigger position at the center of the trace. This specification is used when it is desired to see states before and after the trigger condition. Notice a field to the right of the [a] resource term has been added to the menu for store qualifying data. Store qualifying is explained later in this chapter.
7. Press RUN. The analyzer will begin storing states into memory. When the state specified is found, the analyzer will capture that state and store an additional 512 states. The states captured before the trigger will be identified on the state list with line numbers preceded by minus signs. The trigger and the states captured after the trigger are identified by line numbers preceded with plus signs as in figure 4-25.

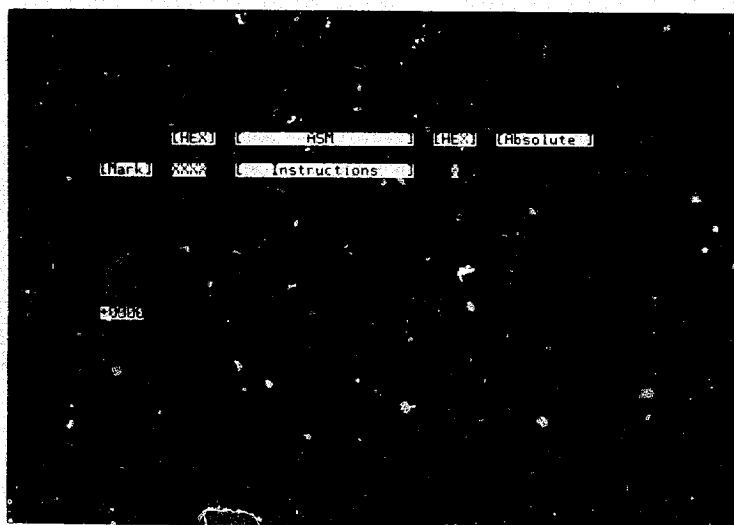

Figure 4-25. Trigger Centers Trace State Listing

8. The trigger may be placed at the end of the trace list in cases where activity after the trigger is not important but activity before the trigger is the necessary data. Press TRACE and select [end] trace on trigger. The analyzer captures activity from the target system until the trigger is found. The trigger condition and the previously captured states are then displayed in the state list, as in figure 4-26.

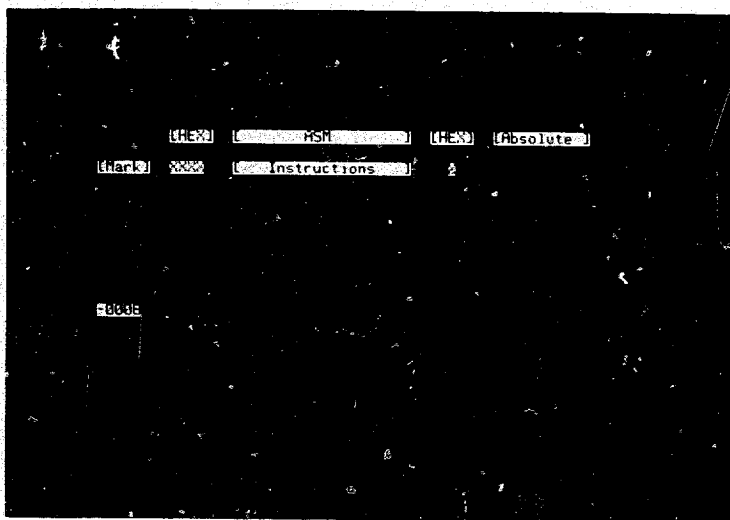

Figure 4-26. Trigger Ends Trace State Listing

SEQUENTIAL TRIGGERING

Sequential triggering is used to trigger the analyzer only after a certain set of events has occurred in the sequence specified. It is used in defining a path of a branching network within the programming of the target system.

For example, figure 4-27 is a typical branch network. The analyzer is to execute a trace at the trigger term 6000, but only if the program has followed path 2 to reach the location 6000. Resource terms can define the trace specifications as: In sequence find [0300], then [0305], then [0500], then start trace on the first [00001] occurrence of [6000].

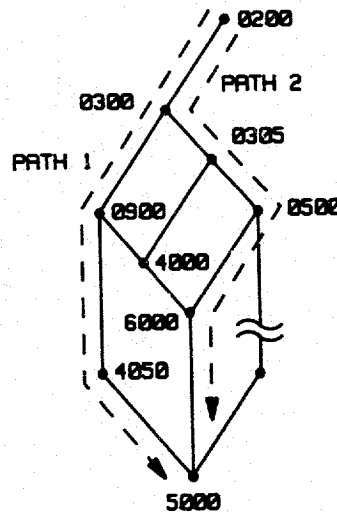

Figure 4-27. Branching Network With Specified Paths

Each resource term arms the analyzer for the next term to be recognized. The analyzer executes the trace only after all the terms have been recognized in the given sequence.

1. Press TRACE and move the cursor to the [start] field.
2. Press INSERT three times to open three fields for sequential triggering. Initially, all fields begin at [a].
3. Use the NEXT[] key to specify the sequence terms of find [a], then [b], then [c], then start trace at [d] as in figure 4-28. Notice the find sequence term [d] may be set for multiple occurrences before the trigger starts the trace.

When using [then] find terms, the analyzer looks for the specified state at any time after the first state specified. The state may occur immediately after the first state or a significant time period later.

NOTE

Step 4 applies only to the 1630G.

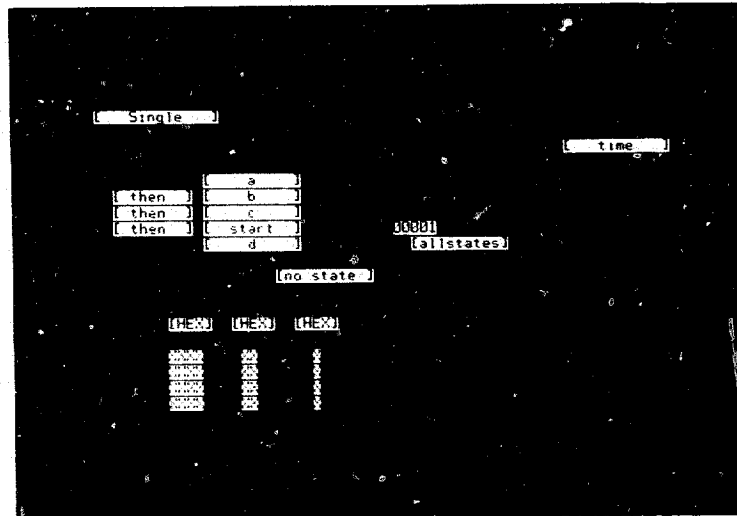

Figure 4-28. State Trace Specification With Sequence Terms

4. Move the cursor to one of the [then] fields on the State Trace Specification menu. Use the NEXT[] or PREV[] key to select [next to]. When [next to] is selected, the analyzer must see the [next to] term immediately following the previous term. If the [next to] term is not seen immediately after the first term, the analyzer will look for the first term again until it is immediately followed by the [next to] term. For example, in figure 4-29, all the [then] terms have been changed to [next to]. With this specification, the analyzer must find [a], immediately followed by [b], immediately followed by [c], immediately followed by [d]. The trace starts at term [d], and [d] will be the first state in the State Listing. If the State Trace Specification is changed to [center] or [end] the trace on [next to] term [d], all the sequence terms will be included in the State Listing, providing the storing [all states] field do not define store qualifiers. Store qualifying is discussed later in this chapter.

NOTE

Notice that the occurrence field is not on the State Trace Specification menu when the start, end, or center trace term is a [next to] term. The trace will always start, center, or end the trace on the first occurrence of the term which makes the occurrence count irrelevant.

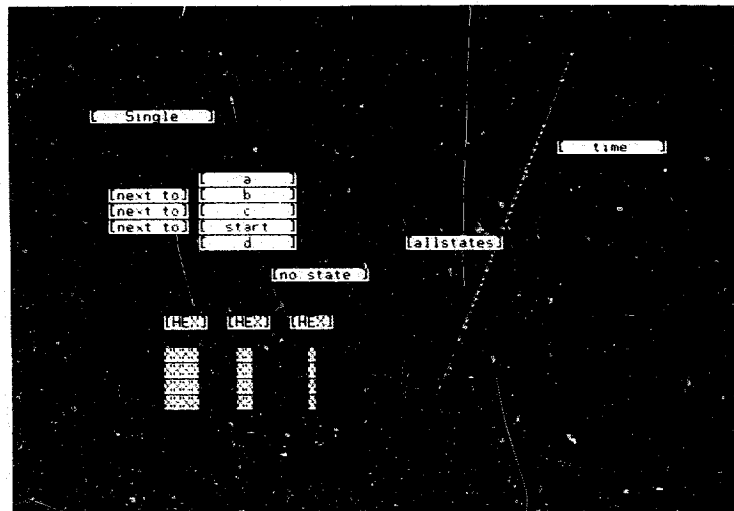

Figure 4-29. State Trace Specification With [next to] Sequence Terms

5. Move the cursor to the [d] resource term and press INSERT three times. Three resource terms are added which may be used to define an ORed relationship to the trigger term. The NEXT[] and PREV[] keys are used to select a specific resource term for each field. The fields provide an ORed relationship for the final trigger term as shown in figure 4-29.

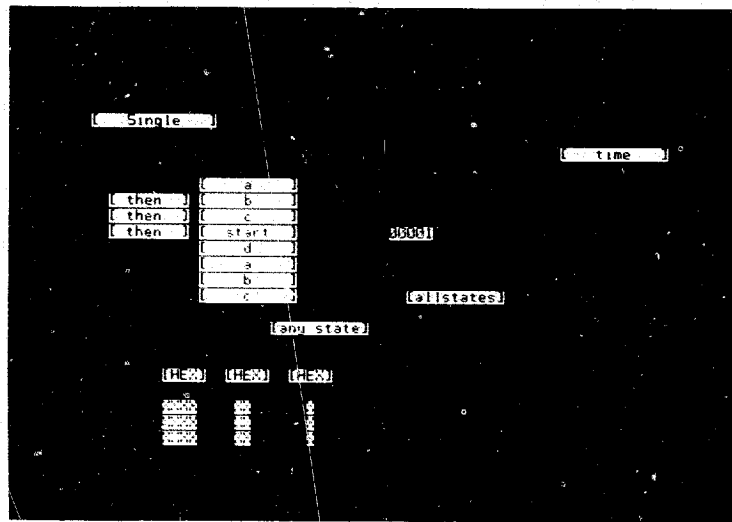

Figure 4-30. State Trace Specification With Sequence Terms and ORed Trigger Starts Terms

SEQUENCE RESTART

Sequence triggering occasionally requires a restart term to ensure the sequence is found in one pass through a branch network. If a restart term is not specified, the analyzer may eventually see all the sequence terms, though not in the path specified, and a trace will be executed. If the logic analyzer finds part of the sequence terms but not all the terms, then finding a sequence restart term will instruct the analyzer to repeat the sequence until all terms are found in the specified sequence.

1. Move the cursor to the sequence restart field.
2. Press NEXT[] or PREV[] to select a restart term.
3. As many as four resource terms may be selected to be ORed with the initial restart term by pressing the INSERT key. The State Trace Specification (figure 4-31) contains the maximum amount of resource terms to be ORed.

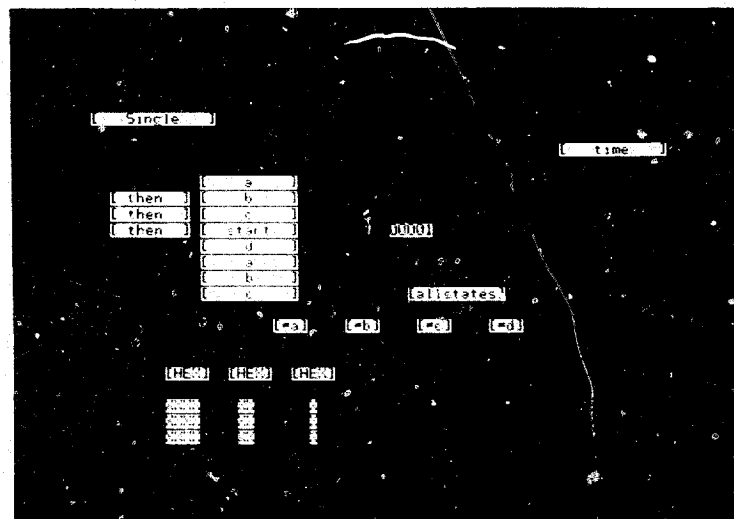

Figure 4-31. Maximum Sequence Restart ORed Resource Terms

STORE QUALIFIERS

Resource terms may be used to qualify data before it is stored by the logic analyzer. When resource terms are used as store qualifiers, only data matching the specified terms will be captured in analyzer memory. Resource terms are used to store qualify data after a sequence of terms are found, or for storing specified terms before a sequence term is found. When used for storing data before terms, the sequence terms are used as breakpoints to change the store qualifiers.

1. Move the cursor to the store [all states] field.
2. Cycle through the resource terms that may be selected by pressing the NEXT[] or PREV[] keys.
3. By pressing INSERT, up to four terms may be specified as store qualifiers to be ORed. The maximum amount of ORed store qualifiers when the trigger starts the trace are shown in figure 4-32.

NOTE

Use ROLL up key to see resource term d.

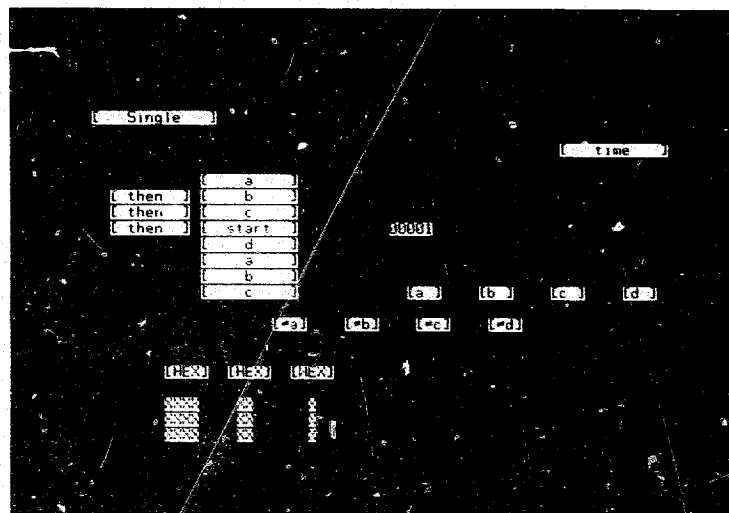

Figure 4-32. ORed Resource Terms as Store Qualifiers When Trigger Starts Trace

4. Move the cursor to the [start] field and select [center] with the NEXT[] key. Three more fields for resource terms are automatically added, one after each of the first three sequence terms. The added fields are shown in figure 4-33.

NOTE

Use ROLL up key to see resource terms c and d.

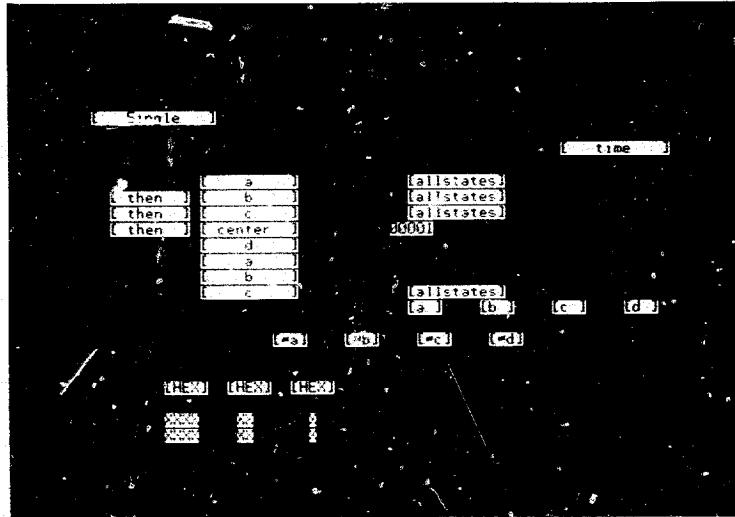

Figure 4-33. Store Qualifying Data Between Sequence Terms

5. Move the cursor to any of the storing fields (while storing on the 1630A/D), and use the NEXT[] or PREV[] key to specify one resource term.
6. To OR store qualifiers between sequence terms, press INSERT to add as many as four ORed store qualifiers. The maximum amount of store qualifiers are shown in figure 4-34. In fact, figure 4-34 contains the maximum amount of resource terms used for sequence triggering, sequence restart, and store qualifying.

NOTE

Use ROLL up key to see resource terms c and d.

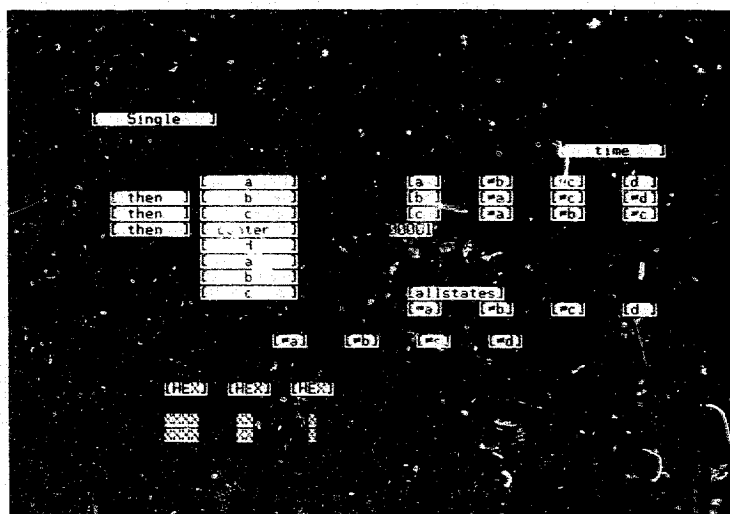

Figure 4-34. Maximum Amount of Resource Terms For the State Trace Specification

[Compare/Edit Compare/Full Compare] Trace Modes

The compare modes of the 1630 Logic Analyzers provide the means to compare traces with previously stored data. In the compare mode, a trigger point is specified and traces are compared with a previously defined compare list of data. The compare modes are useful for production line testing and fault analysis. The trace is checked at selected points with reference to the trigger. For example, a compare list might specify the value FFFF (hex) should be found in the fifth transaction (line + 0005 in the trace memory) after the trigger.

The [Compare] mode of the 1630A/D has been renamed the [Edit Compare] on the 1630G but operates the same. Up to 16 events may be specified to set a basis for comparison for continuous state flow. The comparison events need not be contiguous, but rather are defined by line number in 1630 memory. The compare termination condition may be set for a trace that matches the comparison sequence (compare trace mode [until =]), or when a new state flow fails to match the compare list (compare trace mode [until #]).

1. Press TRACE and use the NEXT[] or PREV[] key to select [Compare] on the 1630A/D or [Edit Compare] on the 1630G.
2. Enter the parameters shown in figure 4-35. The relocation and user base information is the same as previously set up in figures 4-10 and 4-13.

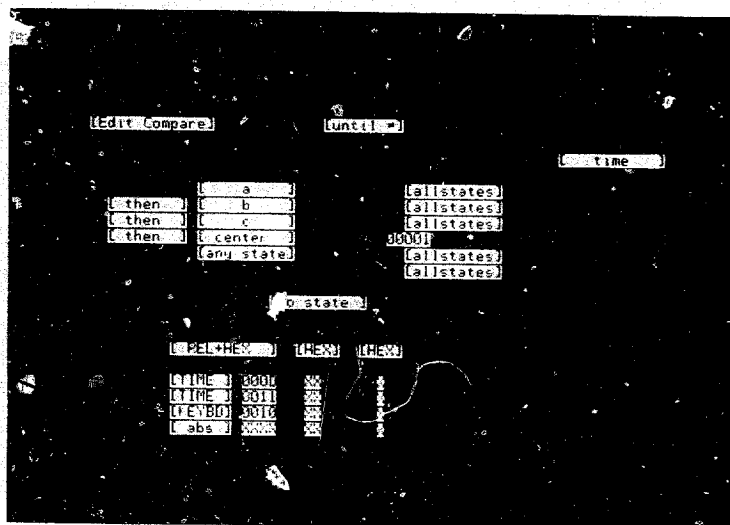

Figure 4-35. [Compare/Edit Compare] State Trace Specification

3. Press RUN to obtain a listing which will be used to compose a compare image. When in a compare mode, the analyzer takes continuous traces. Press STOP to switch into single trace mode and obtain a state listing.
4. The trace will be displayed in the [Compare + State] Listing.
5. Select [Mark] and [Compare Image] to make a compare list.
6. Choose 5 lines for compare events. In figure 4-36 lines -1, 2, 6, 9, and 13 have been selected.
 - a. Move the cursor to the inverse video field at the center of the listing.
 - b. Use the ROLL keys to place each line to be inserted in the inverse video field.
 - c. Press INSERT. The line is entered into the compare list and is marked by inverse video.

NOTE

When using the 1630A/D, move cursor into the inverse video field and enter compare item. DON'T CARE (X) identifies channels which will not be included in the comparison for the line.

d. Up to 16 lines may be entered for the compare list.

NOTE

To delete a line from the compare list, place the line to be deleted in the center inverse video field and press the blue shift key and DELETE.

7. Move the cursor to the [Mark] field and change it to [Show]. The compare list will be displayed as in figure 4-36.

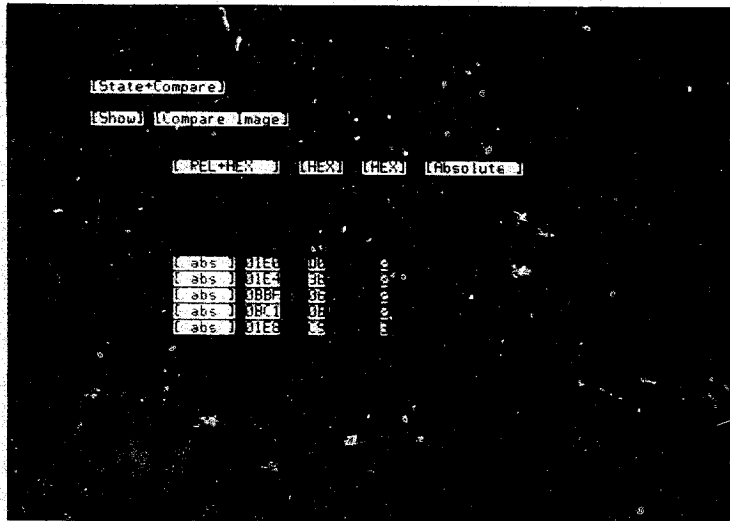

Figure 4-36. The [Compare/Edit Compare] List

8. Press RUN. The analyzer will run a continuous trace until the trace does not have the same events on the lines specified in the compare list. Figure 4-37 is the first trace taken which is not the same as the compare list.

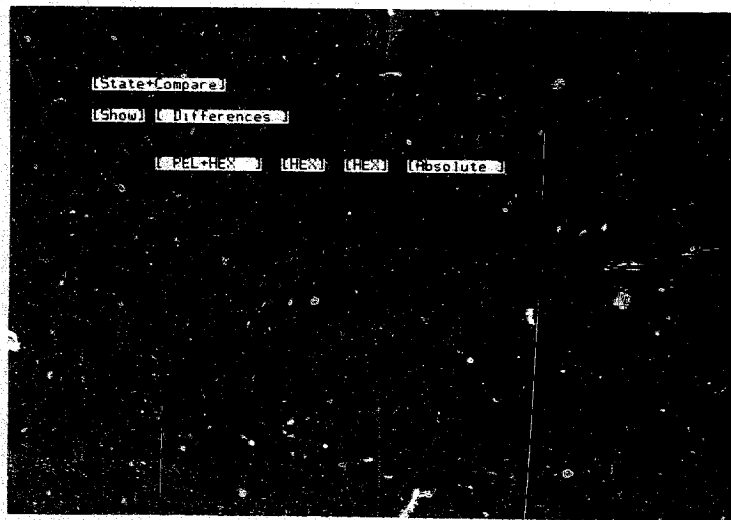

Figure 4-37. Trace Taken in Compare [until ≠] Mode

- Change [Show] to [Mark]. The original listing plus the compare states are displayed in the list, as in figure 4-38. Only the compare states that are different from the original states are marked with an asterisk.

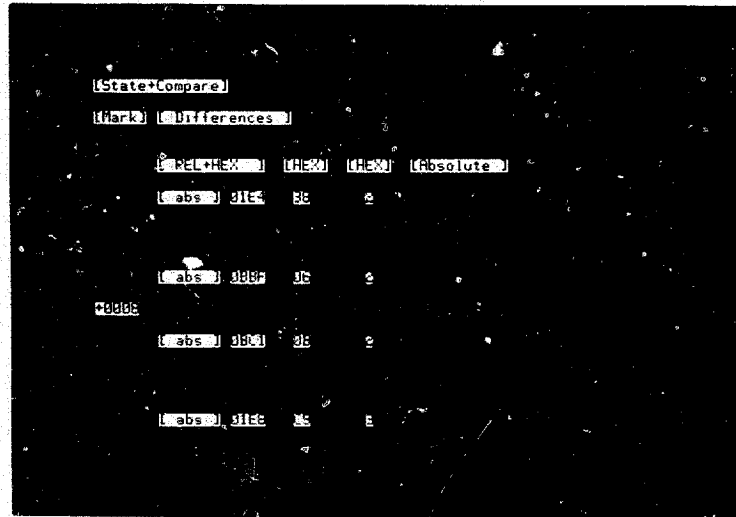

Figure 4-38. Original Compare List with Compare Event Differences

- Pressing RUN will produce different state listings.

The [Full Compare] mode of the 1630G provides the means to compare an entire stored list with a trace.

The [Full Compare] Mode of the 1630G allows comparison of an entire trace of up to 1024 states. The compare termination condition may be set for a trace that matches the compare image (compare trace mode [until =]) or for when a trace fails to match the compare list (compare trace mode [until ≠]).

- Press TRACE and use the NEXT[] or PREV[] key to select [Full Compare].
- Enter the resource terms as shown in figure 4-39.

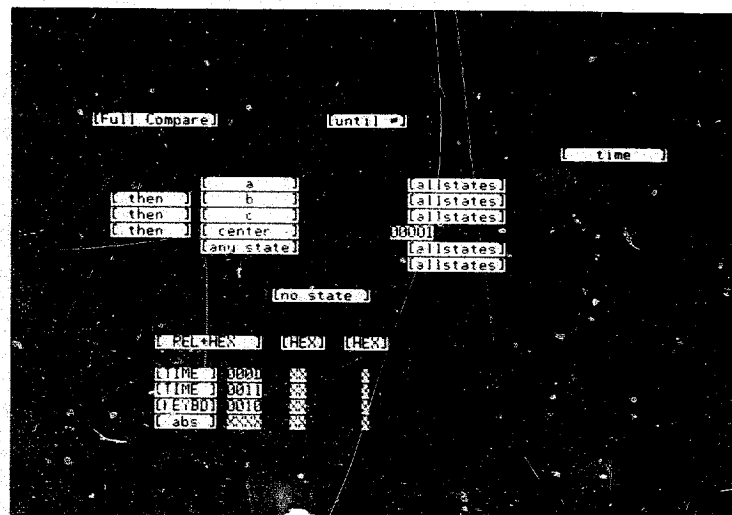

Figure 4-39. [Full Compare] State Trace Specification

3. Press RUN to obtain a trace from which the compare list will be composed. When in a compare mode, the analyzer takes continuous traces. Press STOP to switch into single trace mode.
4. The list will be displayed on the analyzer in the [Full Compare] [Trace] List. A note above the states listed indicates when the compare list is empty. The message at the top of the screen, "INSERT to store compare image", indicates the displayed list may be entered as the compare image.
5. Press INSERT and the entire list will be entered as the compare image. Notice that the note that was previously displayed has been replaced with [Mark] Differences. The [Mark] field may be changed to [Show] Differences with the NEXT[] or PREV[] key.
6. Press RUN. The analyzer will take continuous traces until a trace is not the same as the compare image previously stored with the INSERT key.
7. To re-observe the compare image, move the cursor to the [Trace] field and press the NEXT[] or PREV[] key to select [Image].
8. To enter a new compare image, the display must be showing the [Full Compare] [Trace] List, which will be the last trace that was captured by the analyzer. The message "INSERT to store compare image" will be displayed. Press insert and the new image will overwrite the previously stored compare image.

NOTE

There are certain conditions that cause the analyzer to erase the compare image. If the State Trace Specification menu is changed to [Single] or [Continuous] and an XY Chart or Waveform display is created, the list will be erased. If either SYSTEM [Storage Operations] or [Peripherals] are selected, the compare image will be erased. THE COMPARE IMAGE CANNOT BE STORED ON DISC MEMORY.

THE STATE DISPLAY

List Displays

List displays may be obtained when any of the state trace mode measurements are being performed, except when in the time interval overview mode. The content and use of the list display depends upon which trace mode is being used. Therefore, list displays are discussed for each trace mode.

[Single] LIST DISPLAYS

Figure 4-40 shows a typical list of states that were captured from a logic software system. Line 0000 (the trigger line) is on screen. Lines -0003 through -0001 show three lines of pretrigger information (a pretrigger sequence in the Trace Specification.)

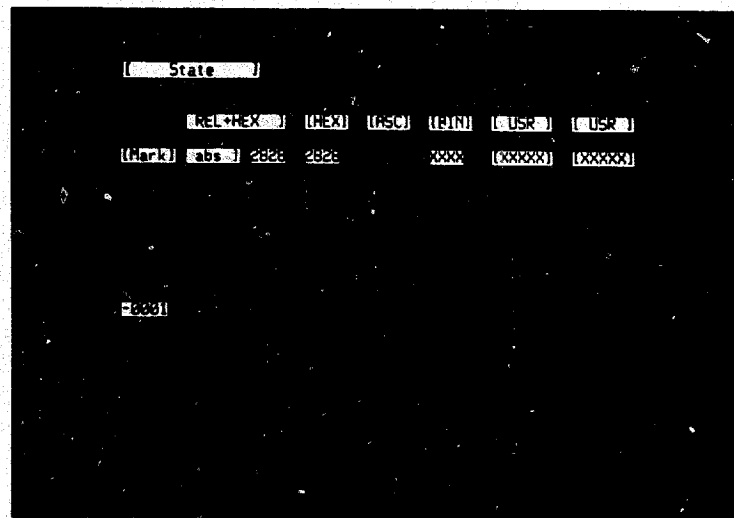

Figure 4-40. Typical List Display In Single Trace Mode

Display Control Fields

Base: hexadecimal, decimal, octal, binary, ASCII (for labels from 6 to 16 bits), user (values assigned in [User Base] menu), and REL+HEX (values assigned in [Relocation] menu).

[Mark]: places asterisk beside each line number that has values specified in [Mark] line.

[Show]: shows only those lines on screen that have values specified in [Show] line.

Line no.: inverse-video field can be changed to any line number in memory. Display window will shift to area in memory which includes selected line.

Display Information: blanked while analyzer gathers states. If states are captured at a slow rate, top line will show count of states still to be captured. After trace complete, up to 16 lines of state memory will be on screen. Every label defined in Format Specification will be on screen (subject to max screen width). Labels can be reordered by placing cursor in the base field under a label and pressing blue SHIFT key plus LABEL right arrow or left arrow key.

Roll Indicator: arrow(s) in upper right hand corner. Indicate whether display window can be positioned up, down, left, or right by ROLL keys.

[Continuous] LIST DISPLAYS

The list in the continuous trace mode is like the list in the single trace mode, except that "Continuous Trace in Process" appears at the top. In this mode, the analyzer makes a continuous series of single traces, updating the display each time it completes a trace. The content of the list will change as each new trace is completed if the display is updated with different information. To stop a continuous trace, press the STOP key. This causes the analyzer to complete its trace in progress and not start a new trace.

[Compare] LIST DISPLAYS

Figure 4-41 shows a typical display that may be obtained in the [Compare/Edit or Full Compare] mode. On the top line, either the display of [State] or [State+Compare] may be selected. If [State] is selected, the display will show only the content of the trace memory, just as you would see in the [Single] trace mode. The [State+Compare] display is unique to the [Compare/Edit or Full Compare] trace modes.

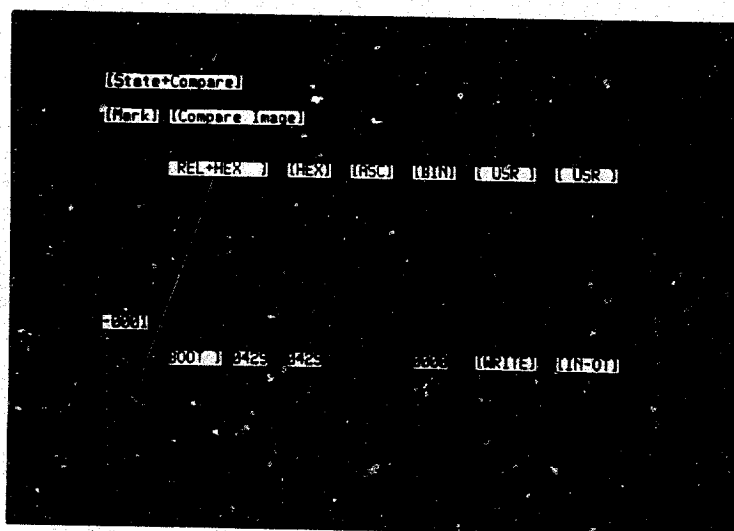

Figure 4-41. Typical List Display In Compare Trace Mode

Display Control Fields

- [Mark]:** places integrated display of trace list and Compare list on screen.
- [Show]:** places only lines of Compare List on screen in [Show] mode or marks lines of Compare List in [Mark] mode.
- [Compare Image]:** all lines of Compare List can be on screen.
- [Differences]:** only lines of Compare List that are different from corresponding lines in trace list can be on screen in [Show] mode or marked in [Mark] mode.

[Overview] LIST DISPLAYS

List or waveform displays may not be obtained when the analyzer is making an overview measurement.

Waveform Displays

Figure 4-42 shows a typical state waveform display. It represents the states on eight channels. Waveform displays may be obtained in any of the state trace modes, except overview. The information on the display is the same, regardless of the trace mode where it was obtained.

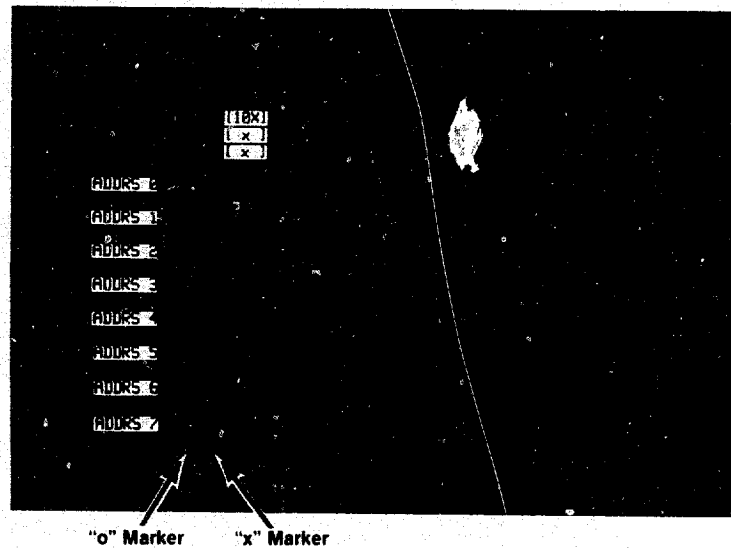

Figure 4-42. Typical State Waveform Display

- Display Content: 1 to 16 channels (X2 vertical magnification with 8 or less channels).
- Channels on Display: any bit in any position, identified by label name and bit number (if in multi-bit label) on left-hand side.
- Display control fields Magnification: selects from 1X to 40X. Bright bar in dotted line at bottom shows position of display window in memory.
- Magnify About: moves magnified display window to area around "x" or "o" markers.
- Cursor Moves: selects "x", "o", or "x&o" markers to be moved by CURSOR keys. Scale at top shows number of states between "o" and "x" on display.
- Bit Labels:
 - press NEXT[] key to bring any bit to any point.
 - press INSERT and DELETE to add or remove channels.
 - press CLEAR ENTRY to turn off a channel.
 - press LABEL up-arrow or down-arrow to move a channel up or down on the display.
- Roll Indicator: arrows in upper, right-hand corner indicate whether display window can be positioned left or right by ROLL keys.

XY Charts Of Label Activity

The analyzer can format XY charts of the activity collected from any labeled set of bits. These charts can show patterns of activity. Figure 4-43 shows a typical XY chart of a label.

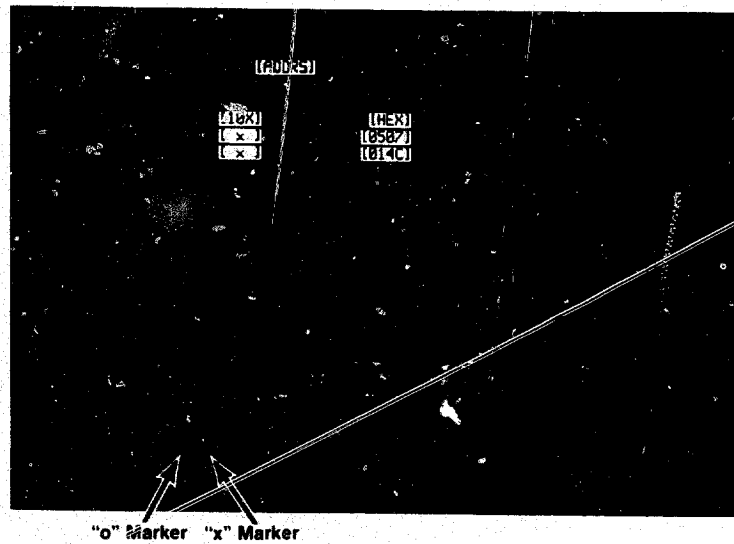

Figure 4-43. Typical State XY Chart Of A Label

Display Control Fields

Magnification:	selects from 1X to 40X. Bright bar on dotted line at bottom shows position of display window in memory.
Magnify About:	moves magnified display window to area around "x" or "o" markers.
Cursor Moves:	selects "x", "o", or "x&o" markers to be moved by CURSOR keys. Scale at top shows number of states between "x" and "o" on the display.
Max and Min:	selects vertical display scale.

Chapter 5. Performance Analysis Measurements

Introduction	5-1
State Label Overview Measurement	5-1
Time Interval Overview Measurement	5-4
Time Positional Measurements	5-6
Linkage Overview Measurements	5-10

Chapter 5

Performance Analysis Measurements

INTRODUCTION

As the software begins to push the limits of the hardware of a system, the need for more efficient code becomes much more apparent. The software must be able to respond to all of its inputs in a timely fashion, with little or no delays. Performance Analysis allows the programmer to analyze code—to find bottlenecks and inefficiencies. The Overview Measurements of the 1630 series logic analyzers (available in the state-only configuration) provide the programmer with tools with which to perform this analysis. These tools allow the programmer to analyze module processor usage, intermodule linkage, module duration, and time-based interaction.

The output of these tools appear as bar graphs (called histograms) relating the relative actions between measured items. These histograms are presented in the chart menu after the trace specification has been set up for an overview measurement. With the exception of the Time Positional measurement, these measurements execute in a continuous random sample mode. A sample consists of 1024 qualified states. The time between states varies randomly to insure random sampling. To stop a measurement immediately, press the STOP key twice. The first press will force the analyzer to take one more sample and then quit. Two consecutive STOPS will force the analyzer to abort the current sample.

The following chapter describes the overview measurements, and provides example usages of these measurements.

The 1630A/D analyzers can show two types of histograms: state label histograms and time interval histograms. The 1630G analyzer can show two types of state label histograms (counting states or program activity), time interval histograms, time position histograms and linkage histograms.

STATE LABEL OVERVIEW MEASUREMENT

State Label Overview Measurement allows the programmer to define module code ranges and then compute the amount of time spent within these modules, relative to each other, or relative to the entire system software. The ranges are defined for one of the eight possible labels defined in the format menu. (For a typical inverse assembler application, these would be ADDR, DATA, and STAT.) The ranges may be defined as any locations between the maximum and minimum values possible for that label.

State Label Measurement is very beneficial in improving overall system performance. It allows the programmer to define sections of code critical to the overall system or module performance, and thereby avoid wasting time attempting to optimize code that does not noticeably affect overall performance.

For example, a module that performs floating point processing is found to be noticeably slow. The floating point module consists of seven routines: F_ADD, F_SUB, F_MUL, F_DIV, F_CMP, F_MOVE, and F_NORM. These routines provide floating point addition, subtraction, multiplication, division, comparison, moves, and normalization. To improve the module performance, the individual routines are defined in the State Label Trace menu, and then analyzed, as in the following steps.

To define the seven routines, first change the label next to the [State Label] field to [ADDR] with the NEXT[] key. (ADDR must be previously defined in the Format menu.) Then move the cursor to the ALL label at the lower left corner of the display. Change this label to "FADD". Then define the low and high addresses for this routine. Add the remaining labels (FSUB, FMUL, FDIV, FCMP, FMOVE, FNORM) by pressing INSERT and filling in the corresponding fields.

Next move up to the [states] field. This defines how memory accesses following opcode fetches will be counted. In the [states] mode, the accesses will be counted individually from the opcode fetches, adding to labels defining the memory area, if such labels exist. In the [program activity] mode, these accesses will be counted along with the preceding opcode fetch in the range of the opcode fetch. Therefore, in the [states] mode, stack accesses are counted as occurring at the stack location while in the [program activity] mode the stack accesses would be counted as occurring in the location of the opcode preceding the stack accesses. For this example, the [states] mode is used. Figure 5-1 is the State Label Overview Trace Specification for this example measurement.

The State Label Trace samples the program activity in groups of 1024 states per sample. In between each sample, a random delay is invoked to insure random sampling. After running the given example, the routine F_NORM was found to consume the majority of the floating point processing time. Refer to figure 5-2. F_MOVE also was found to consume a great deal of processing time. By making the F_NORM and F_MOVE routines more efficient, the module performance could be greatly improved. Therefore, a great increase in module performance could be achieved by modifying only two of the module's routines.

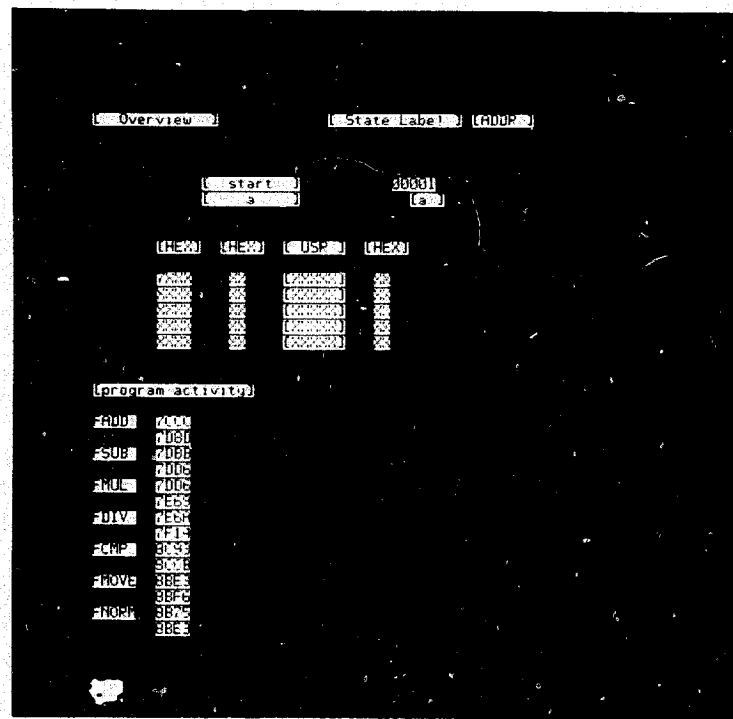

Figure 5-1. Example State Label Overview Trace Specification

NOTE

Use ROLL up key to see entire display.

Sequence Terms:	refer to State Trace discussion.
Trigger Location:	refer to State Trace discussion.
Occurrence Count:	refer to State Trace discussion.
Trigger Term:	refer to State Trace discussion.
Store Qualifiers:	refer to State Trace discussion.
Restart Terms:	refer to State Trace discussion.
Resource Terms:	refer to State Trace discussion.
Count Field:	selects whether memory accesses following an opcode fetch should be counted in the opcode fetch's range or in the range they map into.
Range Labels:	provide names for defined activity ranges. More ranges can be added by pressing INSERT.
Range Fields:	define the minimum and maximum locations for the activity range. More ranges can be added by pressing INSERT.
Readouts Available:	state Label Histogram only.

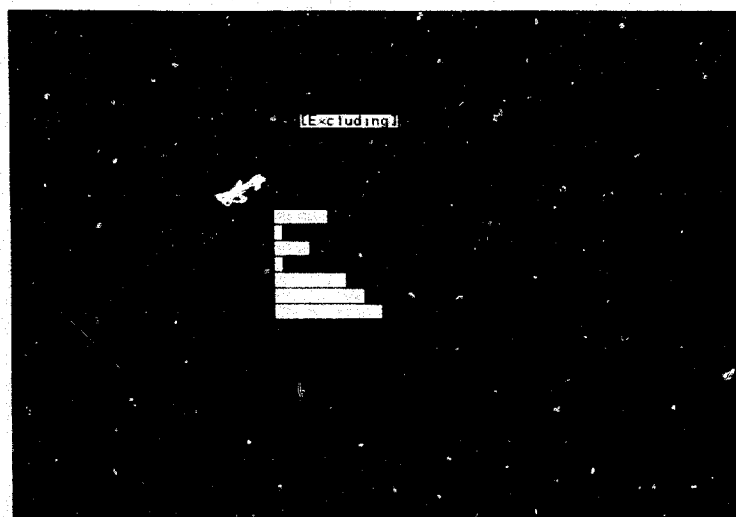

Figure 5-2. State Label Overview Chart of Example Measurement

- Total Samples:** the total number of sampled states acquired and sorted at this point in time.
- [Including] Field:** defines if percentages should be computed from the total samples or from the total number of samples that fall within a defined range.
- Histogram:** provides a percentage-based bar graph of range usage.

TIME INTERVAL OVERVIEW MEASUREMENT

Time Interval Overview Measurement provides a histogram of the time spent within a routine with a known entry and known exit point, or the time spent between transition points. It is useful in finding exceptional cases such as a routine that occasionally runs much too long, or much too short. It also provides information for code optimization, allowing the programmer to optimize the code for the conditions under which a routine operates the most.

For example, consider an interrupt driver that has only one entry point and one exit point. The interrupt driver will call one of six predefined handlers, or will simply return, depending on the current system conditions and register. Each of these handlers returns control to the driver, which returns control to the operating system through its exit point.

The measurement is configured by setting the timer to start on the resource term [a], where [a] defines the address of the entry to the routine, and by setting the timer to stop on the resource term [b], where [b] defines the exit address of the routine. The time ranges are set to likely values by entering values and units for the limits of each of the ranges from 1 to 8. Figure 5-3 is the State Line Interval Overview Trace Specification for this example measurement.

As in State Label Overview, the analyzer runs in a continuous sample mode. A [start] trace is always performed. When this example was run, the histogram in figure 5-4 was generated. The histogram indicates that the majority of the time, the driver operates in the 1.0 ms to 4.0 ms range. It also shows that the driver executes a great deal of the time in the 5.0 μ s to 1.0 ms range. Since the only handler to operate in the latter range is the unknown interrupt case, the results indicate that there is a severe problem with undefined interrupts. The maximum field indicates that one of the handlers can run for over 5.0 ms. Since the handler keeps interrupts turned off during this time, the large processor usage of this handler could be dangerous.

This measurement might also be used to monitor the time elapsed between the acknowledgement and processing of an interrupt. In the case of a clock value update, large delays between the interrupt occurring and the processing of the interrupt could indicate a slowing of the clock value.

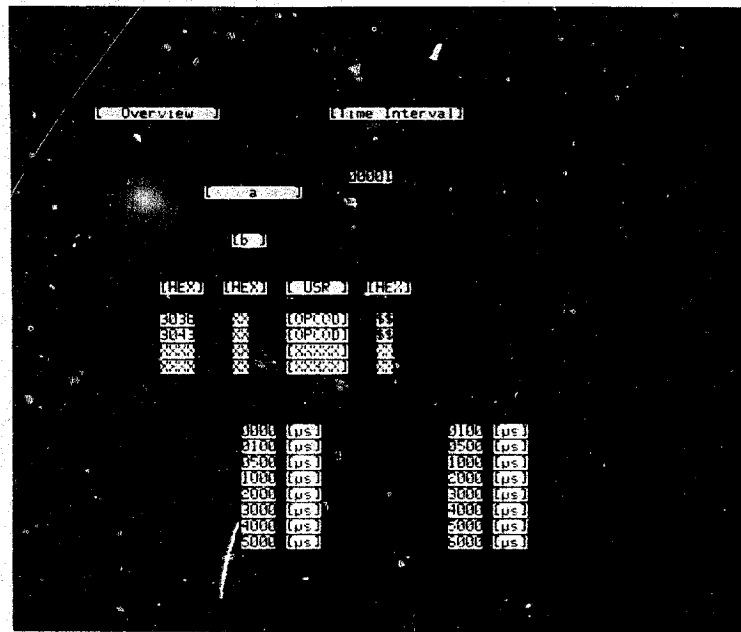

Figure 5-3. Example State Time Interval Overview Trace Specification

NOTE

Use ROLL up key to see entire display.

- Sequence Terms:** one or two sequence terms may be defined. Refer to State Trace discussion for more information.
- Occurrence Counter:** refer to State Trace discussion.
- Start Term:** the matching pattern to be applied to start the counter. This value can be as simple as an [any state] or as complex as four OR'd states.
- Stop Term:** the matching pattern to be applied to stop the counter. This value can be as simple as an [any state] or as complex as four OR'd states.
- Interval Ranges:** the ranges in which the collected data should be grouped into. The left field determines the minimum value of the range and the right field determines the maximum value of the range. These values can be as small as 0 μ s or as large as 9999s.
- Readouts Available:** Time Interval Histogram only.

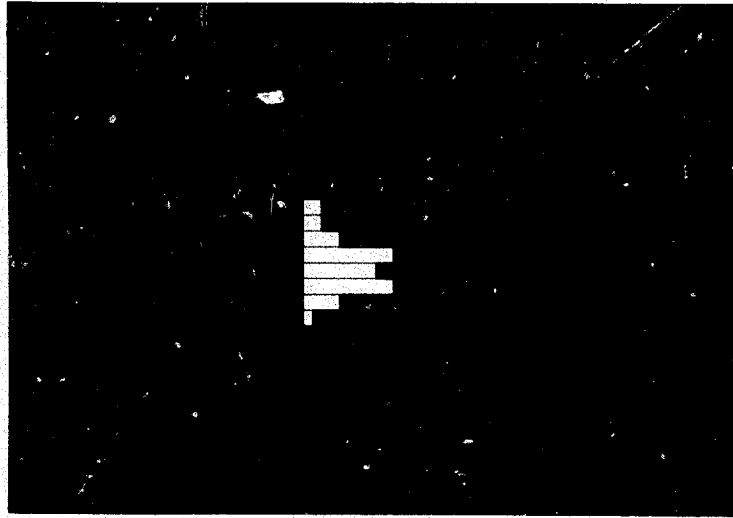

Figure 5-4. State Time Interval Overview Chart of Example Measurement

Total Samples:	the total number of states sampled and sorted at any point in time.
Total Time:	the accumulated time of all of the time intervals recorded on the display.
Minimum:	the shortest time acquired.
Maximum:	the longest time acquired.
Average:	the average time of all the times acquired.
Last:	the duration of the last interval acquired.
Histogram:	a percentage bar graph of the number of intervals acquired that fall within one of the defined ranges.

TIME POSITIONAL MEASUREMENTS

The time positional measurement provides a histogram of the number of occurrences of an event over a specified period of time. This measurement is useful in the counting actions that occur in great quantities, or that occur at large intervals. The period of time is divided into up to 1023 equal sub-intervals. Each of these reports the total number of occurrences of the event during that sub-interval.

For example, to monitor the number of writes to an HP-IB communication chip data register over a ten second period, configure the logic analyzer to measure 1000 periods of 10 ms each. Set both the store qualifier and the trigger term to the resource term [a]. Then set the resource term [a] to the address of the HP-IB chip with a status of [WRITE]. Figure 5-5 is the example measurement State Time Positional Overview Trace Specification.

The measurement will then begin on the first write to the specified address, and will continue for ten seconds. At completion, the chart menu will display a vertical histogram of 1000 bars. Each of these bars represents the number of HP-IB chip writes to occur during that 10 ms sub-interval. Figure 5-6 is the Time Positional histogram chart of the example measurement.

The time positional histogram provides a visual image of the flow of events within the system. In the example provided, the histogram suggests that data is output through the HP-IB port in small bursts with large intervals in between. The histogram also shows that while the burst transfer rate is acceptable, the effective transfer rate for a ten second period is very poor. By reducing the size of the intervals between transfers, the designer could increase the effective transfer rate without attempting to increase the burst transfer rate.

In the upper left corner of the chart menu, the number of occurrences contained within the bars located at the x and o cursors are displayed. The time interval spanned between the cursors is also displayed. When the chart menu is in a magnification of 1X, the sub-intervals are grouped into sets of four with only the bar of the interval containing the largest count being displayed. Likewise, in a magnification of 2X, the sub-intervals are grouped into sets of two. All other magnifications display the sub-intervals individually.

The LIST menu is also available in this overview measurement. It displays the counts contained in each of the sub-intervals along with the absolute time from trigger at which that sub-interval ended. This count can be displayed individually for each sub-interval, or in a cumulative mode by toggling the select field under the "Occurrences" heading. Figure 5-7 is the Time Positional Listing for this example measurement.

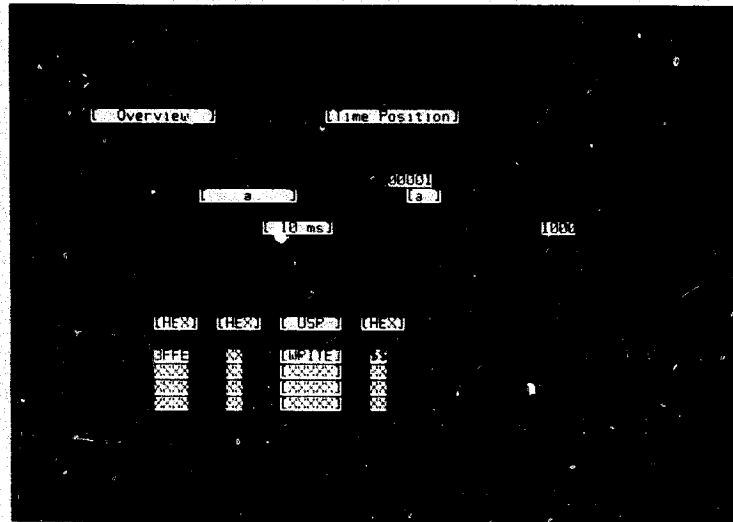

Figure 5-5. Example State Time-Positional Trace Specification

Sequence Terms:	one or two sequence terms may be selected from the resource terms, by pressing INSERT in the occurrence field. Refer to State Trace discussion for more information.
Occurrence Count:	refer to State Trace discussion.
Trigger Term:	refer to State Trace discussion.
Store Qualifiers:	refer to State Trace discussion.
Restart Terms:	refer to State Trace discussion.
Measurement Period:	the length of each sub-interval (from 1 μ s to 200 s.)
Number of Periods:	the total number of sub-intervals to measure.
Readouts Available:	Histogram Chart or Sub-interval List.

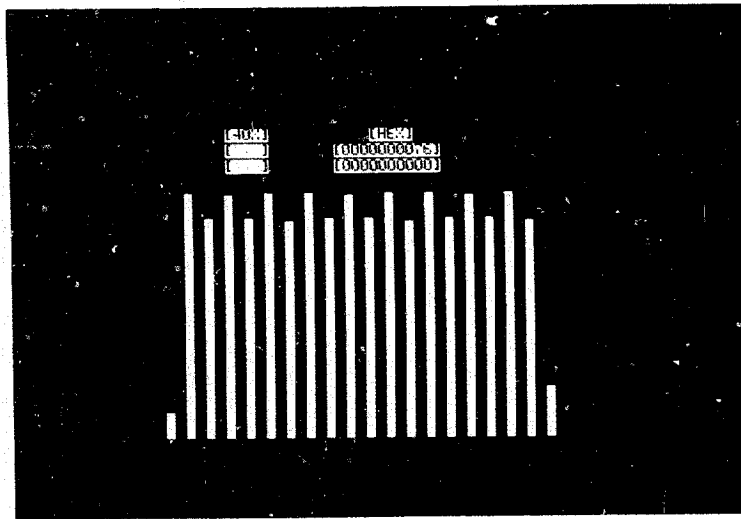

Figure 5-6. State Time Positional Overview Chart of Example Measurement

- Magnification:** the magnification of the chart display from 1X to 40X. The bright bar on the dotted line at the bottom shows position of the display window within the total measurement interval.
- Magnify About:** forces the display to the area around either the "x" or "o" cursor.
- Cursor Moves:** selects either the "x" or "o" cursor, or both cursors, to move when the cursor left or right keys are pressed.
- Max and Min:** select the vertical display area. These can be set to the max and min of the displayed data by pushing INSERT when the "INSERT to autoscale" message appears. A "" will appear by the "Min" or "Max" label if data is being clipped, within the display window, at the top or bottom of the display area.
- "x-Cursor" and "o-Cursor":** display the number of occurrences contained within the bars positioned at the corresponding cursors.
- "Time x to o":** total time spanned between the "x" and "o" cursors.

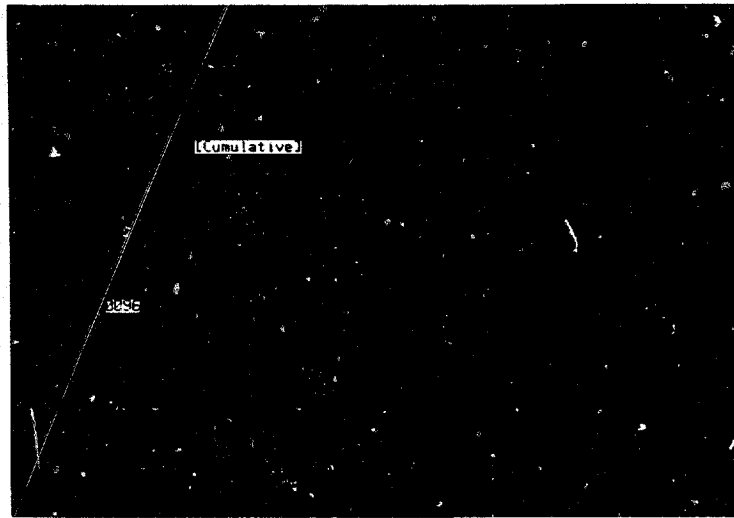

Figure 5-7. State Time Positional Listing for Example Measurement

Interval:	a number from 0 to 1023 representing the sub-interval number.
Occurrences:	the count contained within the corresponding sub-interval in either an individual, or cumulative (relative to the start of the measurement) mode.
Absolute Time:	the amount of time that elapsed from the start of the measurement to the end of the corresponding sub-interval.
Period:	the time length of the individual sub-intervals associated with this data.

LINKAGE OVERVIEW MEASUREMENTS

The Linkage Overview Measurement provides a histogram of the relative number of calls made between modules, or the number of references made to devices or memory locations. A link is defined as two events occurring one immediately after the other in the state memory. Up to eight of these events can be defined, in a manner similar to the definition of resource terms. Up to eight link types, made up of two of any of these defined events, may also be defined. The histogram chart for Linkage Measurement displays the percentage of valid links for a defined link type versus the sum of the valid links found for all of the defined link types.

This measurement is useful in obtaining information about inter-module usage, or for obtaining information about resource usage among several different modules. Therefore, this measurement might be used to monitor the usage of an HP-IB communication chip by tasks performing system HP-IB input and output, printer output, and mass storage input and output. The Linkage Histogram would provide information as to which of the tasks was using the chip the most and which was using it the least. It would also provide information as whether the tasks were using the chip more for input or for output transactions. The measurement can also be useful in finding unexpected usage between modules by using the [other] and [any] events.

Using this example, the events would be defined as the writes from and the reads to the HP-IB chip within the individual modules. (In this case: System in, System out, Printer out, Disc in, Disk out.) Two more events would be defined as the HP-IB routines which write to the chip, given as H_WRT (write) and H_RD (read). To define events, enter the event name in the label field of the "Events" section, and the address, data, and/or status masks in the corresponding fields. More events can be added by pressing INSERT from any one of these fields. Figure 5-8 is the State Linkage Overview Trace Specification for this example measurement.

Link types for this example are: (System in) followed by (read), (System out) followed by (write), (Printer out) followed by (write), (Disc in) followed by (read), and (Disc out) followed by (write). Link types are defined by entering the link type name in the label fields under the "Linkages" section. Events for the link types are selected by using the NEXT and PREV keys to select from the predefined event labels, or to select an [any] or [other]. [any] allows an event to be paired with any state following (therefore, it acts as a "don't care" event). [other] allows a valid link to its paired event when the link is not valid for any other link type with the same paired event. Therefore, if a link type contained a leading event of [other] followed by a trailing event of [H_RD], a link of some state followed by a state matching [HH_RD] would be a valid link for this type only if its leading state did not match any of the leading states of link types with trailing events of [H_RD].

As in the State Label and Time Interval measurements, the logic analyzer runs in a continuous random sample mode. When this example was run, the results shown in figure 5-9 were obtained. The results indicate that the printer uses the HP-IB communication chip more than the other processes. If the effective transfer rate for mass storage were low, these results might indicate that the printer process controls HP-IB chip more often than the mass storage process, and might need its priority lowered.

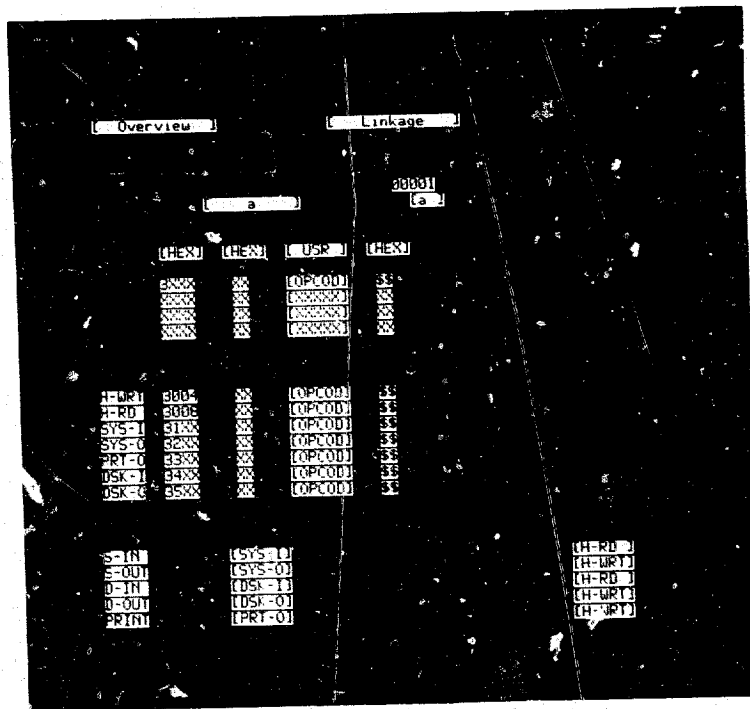

Figure 5-8. Example State Linkage Trace Specification

NOTE

Use ROLL up key to see entire display.

- Sequence Terms: refer to State Trace discussion.
- Occurrence Count: refer to State Trace discussion.
- Trigger Term: refer to State Trace discussion.
- Store Qualifier: refer to State Trace discussion.
- Restart Terms: refer to State Trace discussion.
- Events: the events consist of a label with a pattern matching field. More events can be added by pressing INSERT within one of these fields.
- Linkages: the link types consist of a label and a pair of events, one leading and one following. Events are selected using the NEXT and PREV keys. More link types may be added by pressing INSERT within the label field.
- Readouts Available: Linkage Histogram only.

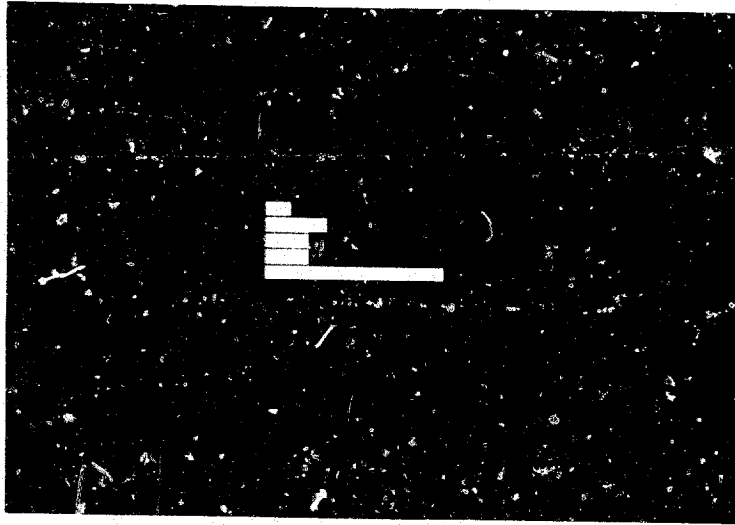

Figure 5-9. State Linkage Overview Chart for Example Measurement

- Total Samples:** the total number of state samples sorted at the current point in time.
- Total Links:** the total number of event pairs from the total samples that matched at least one of the link types.
- Histogram:** bar chart of the percent of total links which matched each of the individual link types. Note: the sum of the percentages may add up to more than 100% if the links found match more than one of the link types.

Chapter 6. Timing Measurements

Introduction	6-1
Glitches	6-1
Triggering	6-1
Simple Timing Measurements	6-1
Activating The Timing Analyzer	6-1
Controlling The Timing Display	6-3
Selecting Trace Positions On The Display	6-4
Triggering On A Timing Event	6-5
The Timing Format Specification	6-7
Timing Format Specification [Assignment]	6-7
Timing Format Specification [User Base]	6-8
The Timing Trace Specification	6-9
[Single] Timing Trace Specification	6-9
[Continuous] Timing Trace Specification	6-9
The Timing Display	6-10
Waveform Displays	6-10
List Displays	6-11
Chart Displays	6-12

Chapter 6

Timing Measurements

INTRODUCTION

Timing analysis is directed toward timing relationships between I/O signals or control lines, and propagation delays between or across logic gates.

When the logic analyzer is configured for timing analysis, samples of data are taken, asynchronously, on every pulse of a clock internal to the analyzer. The analyzer determines whether the data is less or greater than a prespecified threshold voltage level and displays the result as either a logic 1 or 0. The display stays at the same level until the next sample is taken.

Glitches

Glitches are handled by a glitch detection circuit which is independent of the sampling rate. Dual detectors are on an alternate sample period with a slight overlap. Each detector looks for two threshold crossings, identifying a glitch. If a glitch is found, it is stored in a memory separate from the timing data. When glitch detection is on, the assigned timing channels are halved.

Triggering

Trigger detection is accomplished by a method independent of the sampling clock. To eliminate false triggering, the analyzer has a filter which is used when specifying trigger duration. Trigger pattern duration is selectable from 20ns to 1ms to qualify the trigger on a time basis.

Edge triggering is available on four channels per pod assigned to timing measurements. It is used where a pattern may not be adequate for triggering or may be used to qualify a pattern. With edge detection, triggering can take place on an edge that doesn't show up in the trace (glitch triggering).

When the analyzer finds the trigger, the tracepoint is positioned as specified in the specification menu (at start, center, or end of trace). The trace specification tells the analyzer when to stop the measurement. Enough information is captured after the trigger to place it properly in trace memory. Usually timing measurements are taken with the trigger in the center trace position. The tracepoint may be delayed up to 9999 seconds after the trigger.

SIMPLE TIMING MEASUREMENTS

The following procedure shows how to make measurements of time-related activity in logic systems. How to trigger traces of electrical activity and how to compose desired displays and measure activity on the displays are described in step by step processes.

Activating The Timing Analyzer

1. Press the SYSTEM key.
2. Press the ROLL down key one time or CURSOR down key two times. This moves the bright bar to the second analyzer configuration. All channels which can collect timing information are activated for timing measurements.

No channels are active for state measurements. See figure 6-1.



Figure 6-1. Selecting the Timing Analyzer Configuration of the 1630D (1630A and 1630G have 8 less channels)

3. Press the RUN key. The analyzer will execute a measurement at the default specification (trigger on anything), and present a waveform display on screen. This display is at X1 magnification. It shows the entire 1K memory content on screen. Unconnected timing bits are constant lows. See figure 6-2.

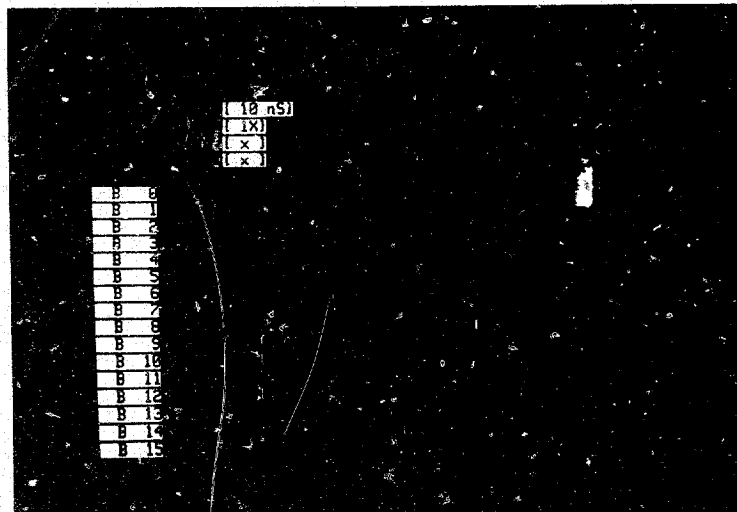

Figure 6-2. Default Timing Measurement For 1630D (1630A and 1630G have 8 less channels)

Controlling The Timing Display

1. Move the cursor to the Magnification field in the Timing Waveform Diagram.
2. Press the NEXT[] key to obtain 4X magnification. This shows a window in the timing memory. One-fourth of the memory is on screen.
3. Press the ROLL down key to see the window move through the timing memory (display moves across the screen).
4. Press the NEXT[] key several times to see the magnifications available. Select a magnification factor that leaves several waveform transitions on screen.
5. Press and hold the CURSOR right key until the "x" marker moves out onto the display area. Place the "x" marker on one of the waveform transitions on the display. The first line above the waveforms on the right-hand side of the screen shows the measurement of time between the start of the memory and the position where you placed the "x" (o to x).
6. Press the NEXT[] key several times to see that magnification of the display occurs around the area in memory you selected by the position of "x". See figure 6-3.

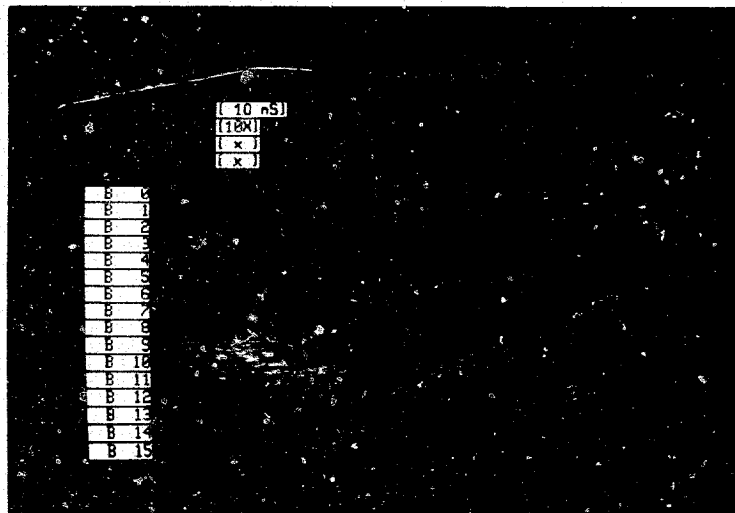

Figure 6-3. Magnification Around "x"

7. Press the CURSOR down key to move the cursor to the Magnify About field.
8. Press the NEXT[] key to change "x" to "o".
9. Move the cursor up into the Magnification field.
10. Press the NEXT[] key several times. Notice that display magnification now occurs around the position of "o" (at the start of the timing memory).
11. Select a magnification that leaves the "x" marker on screen.
12. Press the CURSOR down key to move the cursor to the Cursor Moves field.
13. Press the NEXT[] key to change "x" to "o".

14. Press the CURSOR right key and hold it to move the "o" out on the display. Notice the time measurement indication change as the "o" moves closer to the "x".
15. Place the "o" marker on another waveform transition on the display.
16. The time measurement indication on the display will show you the measure of time between the two waveform transitions you selected using the "x" and "o" markers.
17. With the cursor in the Cursor Moves field, press the NEXT[] key to obtain the [x&o] indication. With this selection, the "x" and "o" markers will move together and maintain a constant interval between them. You can use these two markers together to compare intervals between any two points of interest on the display.
18. Move the cursor into the Magnification field and use the NEXT[] key to obtain a X1 display.
19. Use the CURSOR right and CURSOR left keys to move the "o" and "x" markers together to another set of waveform transitions on the display.
20. Place the "x" marker on one of the waveform transitions.
21. Move the cursor down into the Cursor Moves field and press the PREV[] key to select Cursor Moves [o].
22. If the events are not the same distance apart as the first set, use the CURSOR keys to move the "o" marker alone. You can measure the dimension between the two new waveform transitions.
23. Press the CURSOR left and CURSOR right keys. Notice that the "o" marker can cross the "x" marker, and the measurement indication above the traces will correct itself (show "x to o" or "o to x").

Selecting Trace Positions On The Display

1. Press the CURSOR down key to move the cursor into the B5 field.
2. Press the PREV[] key several times. You can place any of the bits from the timing memory at any location on the display. You can also turn off a display channel, if desired.
3. Press the DELETE key several times. You can eliminate channels from the display, if desired. Note that the vertical display is magnified when eight or less channels are on screen.
4. Press the INSERT key several times. You can add channels to the display, up to a maximum of 16 channels in non-glitch mode and 8 in glitch mode. See figure 6-4.
5. Press the blue SHIFT key and DEFAULT. This restores all channels in the display to their original positions.



Figure 6-4. Selecting Waveform Positions On Display

Triggering On A Timing Event

1. Find a point on the waveform display where two of the channels are high at the same time that one of the other channels has a transition from low to high (change display magnification, if necessary). Write down these three channel numbers and their conditions.
2. Press the TRACE key.
3. Use the CURSOR keys to place the cursor in the row of X's in the Pattern field. This is an AND field. Its default state is all don't cares. All "1" or "0" specifications that you enter in this field must be met during the same clock period in order for the timing analyzer to recognize its trigger.
4. Use the CURSOR keys to place the cursor at the points in the Pattern field which correspond to the bits that you noted as having high states. Enter a "1" from the keyboard in each of these two bits. (B0 is the first bit on the right-hand side of the field.)
5. Use the CURSOR keys to place the cursor in the Edge field. The Edge field is an OR field. You can specify recognition of low-to-high transitions, high-to-low transitions, or both transitions in any of the bits where such selections are available. If any of the selected transitions occurs in any bit during a clock period, the entire field is satisfied.
6. Use the CURSOR keys to position the cursor on the point in this field corresponding to the bit you noted as having a low-to-high transition (B0 is on the right-hand side).
7. If there is a dot in the field where you positioned the cursor, press the NEXT[] key one time to obtain the rising-edge arrow. If there is an N/A (not available) notation in this field, you will have to return to the WFORM display and select new channels, a different one with a low-to-high transition and two other channels that are high, if required. Edge recognition is not available for all of the timing bits. See figure 6-5.

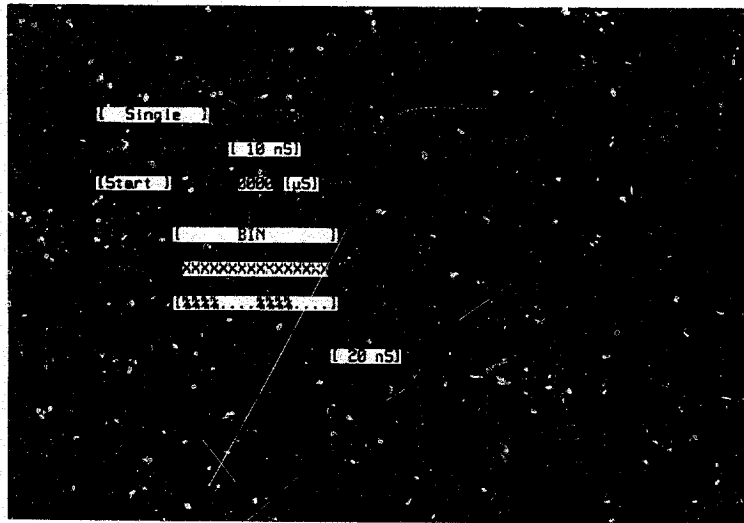

Figure 6-5. Triggering On A Pattern And Edge Transition

8. Press the RUN key. The analyzer will search the incoming activity until it finds a clock period in which both of the high channels you specified are high and a low-to-high transition occurs in the channel you selected. Then the analyzer will trigger a trace and fill its memory.
9. See figure 6-6. Note the vertical, dashed line on the display. This line identifies the trigger point.
10. Move the cursor up into the Sample Period field and press the NEXT[] key several times.
11. Press the RUN key to take a measurement using the new sample period.

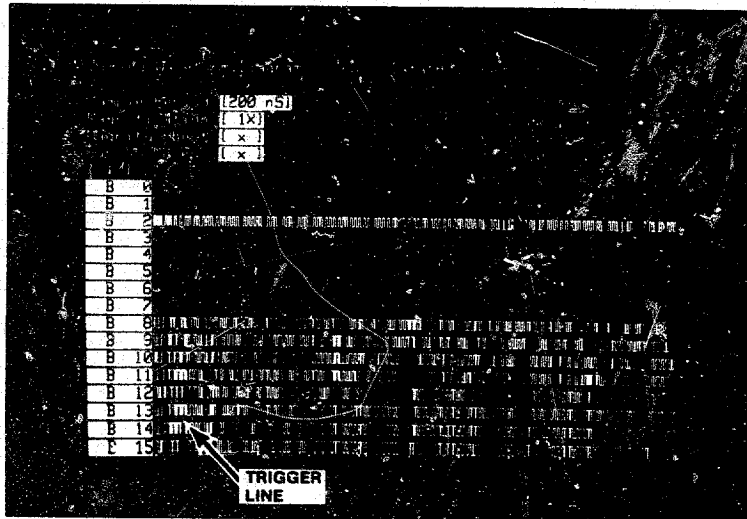

Figure 6-6. Triggering On A Timing Event

THE TIMING FORMAT SPECIFICATION

Timing Format Specification [Assignment!]

The [Assignment] menu allows you to set up the analyzer to present information in a format that will be useful. In the [Assignment] menu, you perform two setup assignments: label assignments and threshold assignments. See figure 6-7.

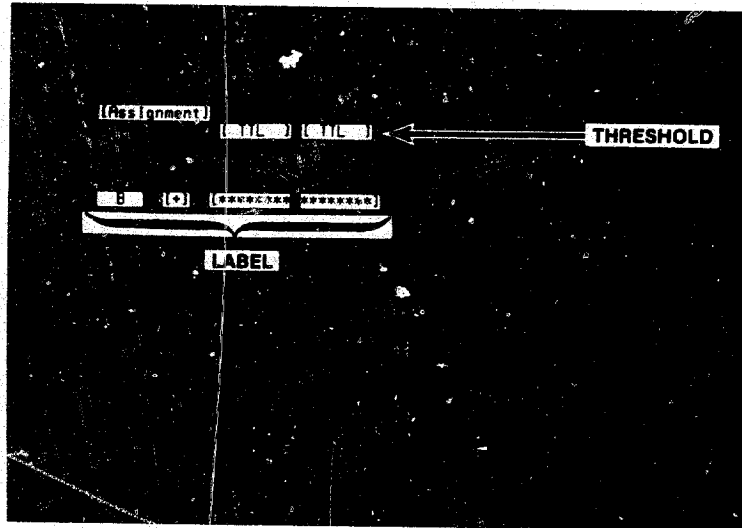

Figure 6-7. Timing Assignment Format Specification

LABEL ASSIGNMENTS

When the analyzer makes a measurement, it collects the states from all input bits (whether part of a label or not). When a label is assigned to a bit, that bit is available to the display. The analyzer cannot place the activity from a bit on the display unless that bit has a label assigned to it.

A benefit of labeling sets of bits during a timing analysis is that abnormal occurrences can be easily identified, such as when two handshake lines are high during the same instant of time.

The label capabilities and limitations are as follows:

- Maximum no. of labels: 16
- Label size: 1 to 5 alphanumeric characters.
- Label content: 1 to all bits. Same bit can be included in all labels.
- Label polarity: [+] = positive-true; [-] = negative-true (only affects LIST displays and TRACE specification).
- Label bit arrangement: (Example of 4-bit label)

	POD1	POD0	
	7...0	7...0	
HNSK	**	**	
	
MSB	1 1	1 1	LSB

Pod Threshold Assignments

The pod threshold capabilities and limitations are as follows:

Pod assignments: Each pod defined separately.
 Thresholds available: TTL, ECL, selectable from -9.9 V to +9.9 V, in 0.1 V increments.

Timing Format Specification [User Base]

The [User Base] menu allows names to be displayed in place of numbers when identifying states found on labeled bits. Different names can identify each of the states, such as "ACTIV" and "INACT" to identify the two states found on the interrupt bit.

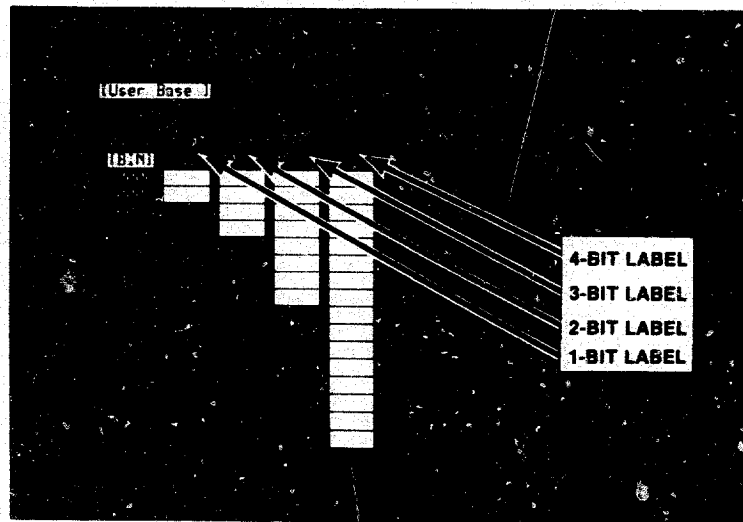

Figure 6-8. Timing User Base Format Specification

The [User Base] capabilities and limitations are as follows:

Max labels on menu: 8.
 Label size: 1 to 4 bits.
 Max names/label: One name for each possible value (16 names on a 4-bit label).
 Name Composition: 1 to 5 alphanumeric characters.

THE TIMING TRACE SPECIFICATION

There are two timing trace modes offered by the analyzer: [Single], and [Continuous]. These two trace modes are described separately in the following paragraphs. Figure 6-9 is the timing trace Specification menu.

[Single] Timing Trace Specification

The [Single] trace mode is used to capture a single trace of timing activity for each bit in the timing probe pod(s). This menu allows selection of sample period, trigger location, trigger activity, and trigger duration.

[Continuous] Timing Trace Specification

In the [Continuous] mode of timing measurement, the analyzer performs a measurement just like in [Single]. As soon as the measurement is complete and the display is updated, the analyzer begins another measurement. This will continue until STOP is pressed.

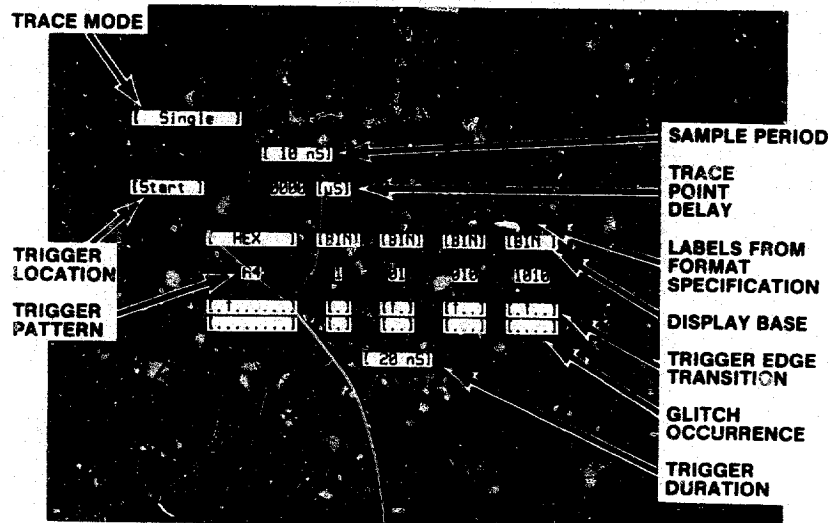

Figure 6-9. Timing Trace Specification (with [Glitch] Selected)

Sample Period:	from one sample every 10 ns to one sample every 500 ms (24 sample period selections)
Trigger Location:	[Start], [Center], or [End] (determines amount of pretrigger and posttrigger time in memory).
Trigger:	combination of pattern and edge.
Pattern:	"And" field composed of 1, 0, or X logic levels on all bits in all labels.
Edge:	"OR" field composed of positive-going, negative-going, either-edge, or off [.] for each capable bit. Bits not capable of edge recognition are identified by N/A.
Duration:	from 20 ns to 1 ms (period that pattern must remain stable to be recognized as trigger) in 1, 2, 5 sequence.
Trace Point Delay:	from 0000 ns to 9999 sec after trigger recognition. Max delay depends on Sample Period selected. Note: the analyzer rounds off the delay entry to the nearest multiple of four times the selected sample period.

THE TIMING DISPLAY

The analyzer can present three kinds of displays: waveforms, lists, and XY charts. These displays are described in this chapter.

Waveform Displays

Figure 6-10 is a typical timing waveform display. It shows the states of six channels during a measurement. The probe channels shown on the waveform display are identified on the left-hand side of the display by their label names and numbers which identify bit positions within the label.

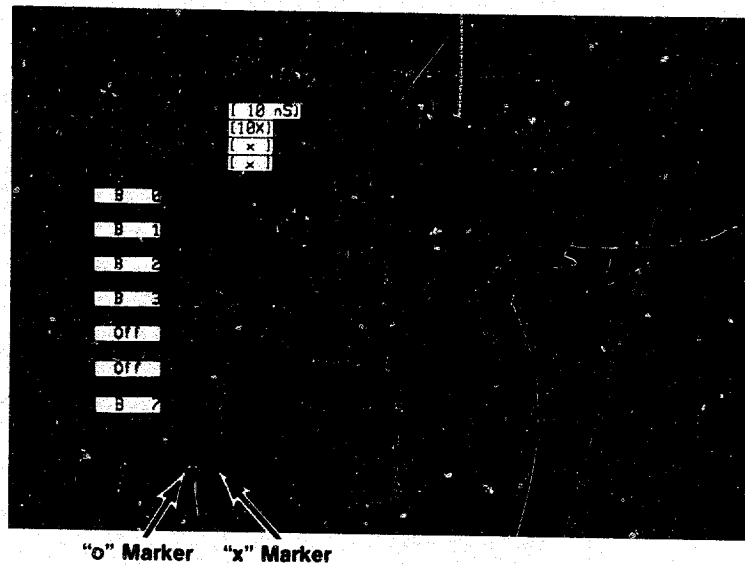

Figure 6-10. Typical Timing Waveform Display

Display Content:	1 to 16 channels (X2 vertical magnification with 8 or less channels.)
Channels on Display:	Any bit in any position, identified by label name and bit number (if in multi-bit label) on left-hand side.
Display control fields	
Sample Period:	10 ns to 500 ms. Sample period may be changed and obtain new traces when in this menu.
Magnification:	selects from 1X to 40X. Bright bar in dotted line at bottom shows position of display window in memory.
Magnify About:	Moves magnified display window to area around "x" or "o" markers.
Cursor Moves:	Selects "x", "o", or "x&o" markers to be moved by CURSOR keys. Scale at top shows time period between "o" and "x" on display.
Label Moves:	Shift and cursor changes order of labels.
Bit Labels:	Press NEXT[] key to bring any bit to any point. Press INSERT and DELETE to add or remove channels. Press CLEAR ENTRY to turn off a display channel. Press LABEL up-arrow or down-arrow to move a channel up or down on the display.
Roll indicator:	arrows in upper right-hand corner indicate whether display window can be positioned left or right by ROLL keys.

List Displays

List displays can be obtained when timing measurements are being performed. Figure 6-11 is a typical list of timing information captured from a logic software system. The time column shows the absolute time interval between each line of information and the trigger line.

The message "Continuous Trace in Process" appears at the top of the display when in the [Continuous] trace mode. In this mode, the analyzer makes a continuous series of single traces, updating the display after it completes each trace. The content of the list will change after each new trace is completed if the display is updated with new information. To stop a continuous trace, press the STOP[] key. This causes the analyzer to complete the trace it has in progress and not to start a new trace.



Figure 5-11. Typical List Display Of Timing Activity

Display Control Fields

- | | |
|----------------------|--|
| Base: | hexadecimal, decimal, octal, binary, ASCII (for labels from 6 to 16 bits), and user (values assigned in [User Base] menu). User values not specified are shown in hexadecimal numbers. |
| [Mark]: | places asterisk beside each line number that has values specified in [Mark] line. |
| [Show]:
Line no.: | shows on: those lines on screen that have values specified in [Show] line. inverse-video field can be changed to any line number in memory. Display window will shift to area in memory which includes selected line. |
| Display Information: | Blanked while analyzer gathers activity. If timing activity is captured at a slow rate, top line will show amount of memory still to be filled. After trace complete, up to 16 lines of activity from memory will be on screen. Every label defined in Format Specification will be on screen (subject to max screen width). Labels can be reordered by placing cursor in the base field under a label and pressing the blue SHIFT key plus LABEL right-arrow or left-arrow key. |
| Roll Indicator: | arrow(s) in upper right-hand corner. Indicate whether display window can be positioned up, down, left, or right by ROLL keys. |
| Time column: | shows absolute time between each sample and trigger line. |

Chart Displays

The analyzer can format XY charts of the activity collected from any labeled set of bits. You can use these charts to see patterns of activity. Figure 6-12 is a typical XY chart for label A (a label composed of four bits).

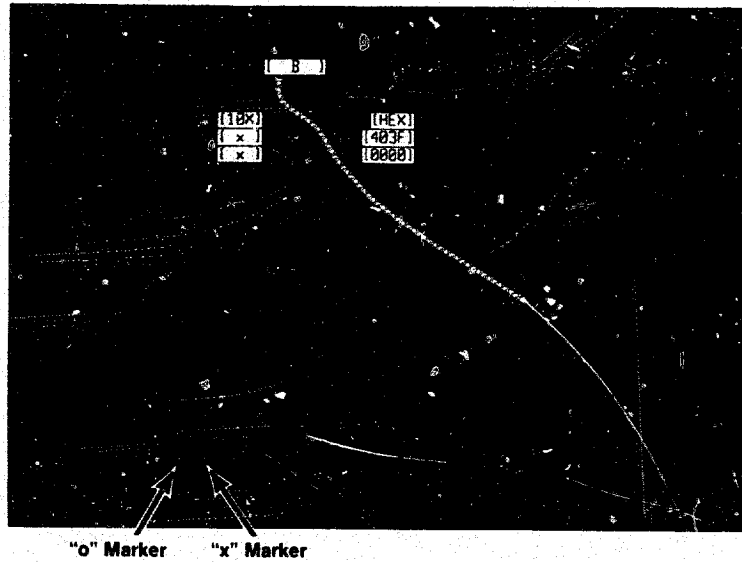

Figure 6-12. Typical Timing XY Chart Of A Label

Display Control Fields

- Magnification:** selects from 1X to 40X. Bright bar on dotted line at bottom shows position of display window in memory.
- Magnify About:** Moves magnified display window to area around "x" or "o" markers.
- Cursor Moves:** selects "x", "o", or "x&o" markers to be moved by CURSOR keys. Scale at top shows period of time between "x" and "o" on the display.
- Max and Min:** selects vertical display scale.

Chapter 7. Interactive State And Timing Measurements

Introduction	7-1
The Format Specification	7-1
The Trace Specification	7-1
Interactive State/Timing Displays	7-1
Interactive State/Timing Triggering	7-1
Special Use For Stop Key	7-2
Making Coordinated State And Timing Measurements	7-2
Setup For State And Timing Measurements	7-2
Executing Coordinated Measurements	7-4

Chapter 7

Interactive State and Timing Measurements

INTRODUCTION

The analyzer can perform simultaneous state and timing measurements when in interactive state and timing mode. The capabilities of the analyzer are nearly the same as when performing dedicated state or timing measurements. The analysis mode named as master finds the specified trigger point and arms the second analysis mode. If the second analyzer is set in a free-run mode, it effectively is triggered by the master analyzer. By using the interactive analysis modes, asynchronous and synchronous signals from the target system may be correlated.

THE FORMAT SPECIFICATION

The FORMAT Specification menus for [State] and [Timing] will show only the probe bits assigned to each analysis function. The capabilities and limitations of the Format Specification menus are the same as when performing state-only or timing-only measurements.

THE TRACE SPECIFICATION

The TRACE Specification for [State] and [Timing] is the same as described in chapter 4 for state measurements and in chapter 6 for timing measurements except for operating modes and the Master field.

- Operating Modes:
1. [Single/Continuous/Compare] in the 1630A/D.
 2. [Single/Continuous/Edit or Full Compare] in the 1630G.
 3. Both state and timing analyzers operate in the same mode. [Overview] performance analysis measurements not available in the interactive state/timing mode.

Master: Selects one analysis function, either state or timing, to look for its trigger before the other can look for a trigger.

INTERACTIVE STATE/TIMING DISPLAYS

The information available in LIST and WFORM displays is the same as in the dedicated [State] and [Timing] modes. The XY CHART displays are the same as in dedicated [State] or [Timing] modes. Overview histogram displays are not available when the analyzer is used for interactive state/timing measurements.

INTERACTIVE STATE/TIMING TRIGGERING

When making a combined measurement, one of the measurement functions will be designated Master and the other one Slave. When a trace begins, the Master will look for its trigger and the Slave will be disabled. When the Master finds its trigger, it will send the "trigger found" information to the Slave. This will allow the Slave to look for its trigger.

The trigger points in the state and timing memories will be nearly the same points in time as long as the measurement function performing as slave has a "don't care" trigger. Except for the trigger point, there will be no correlation between states stored in the state memory and points of activity stored in the timing memory.

There is a case where the measurement function performing as Slave will store its trigger before the measurement function performing as Master. This occurs when the trace point defined for Master is a trigger condition plus a delay period, and the trigger condition for Slave is "don't care" with no delay. When the trace begins, the Master will look for its trigger, and the Slave will be disabled. When the Master finds its trigger, it will send the "trigger found" information to the Slave. The Slave will find and store its trigger immediately, but the Master will wait until after it has counted its specified delay.

SPECIAL USE FOR STOP KEY

When making an interactive measurement, the state and timing measurement functions must both complete their measurements before the results of either measurement can be viewed. If one of the functions does not complete its measurement, the analyzer may display a message such as "waiting for trigger". If the STOP key is pressed, the display of information from the function that was completed can be viewed. The function that failed to complete will not offer a display because its information will not be meaningful.

MAKING COORDINATED STATE AND TIMING MEASUREMENTS

The following procedure shows how the state and timing measurement functions can perform independent measurements using separate trigger events at the same time. This procedure also demonstrates the ability of one of the measurement function modes (state or timing) to arm the other function to perform its trigger recognition.

Setup for State and Timing Measurements

1. Press the SYSTEM key.
2. Press the ROLL down arrow key to select the combined state and timing system specification assigning 8 channels to the timing analyzer. Figure 7-1 is the system specification of the 1630D. The 1630A will have 27 state and 8 timing channels assigned in the interactive mode. The 1630G will have 57 state and 8 timing channels assigned in the interactive mode.

NOTE

The figures in this chapter are taken from the 1630D Logic Analyzer.

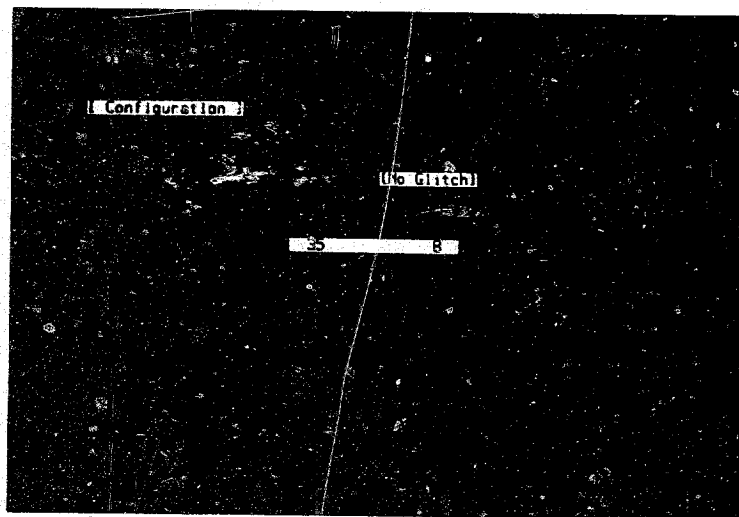

Figure 7-1. Combined State/Timing Analyzer System Configuration for the 1630D

- Press the FORMAT key. Set up the [Assignment] menu the same as in figure 7-2. There are two differences in this menu in interactive mode: the least significant pod (8 bits) is omitted and the Multiplex field now has eight fewer bits in the master clock field. The [Relocation] modules have been set-up as in figure 3-10.

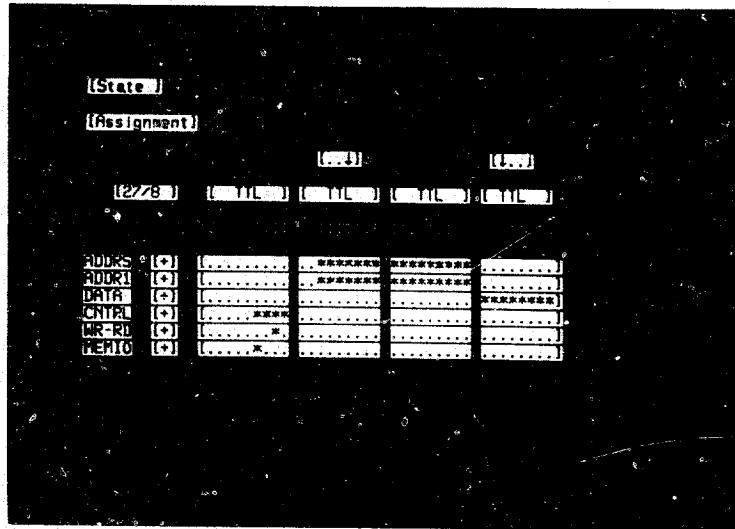

Figure 7-2. State Assignment Format Specification

- Press the TRACE key. The state trace specification will be on screen. See figure 7-3. Set up the trace specification to trigger when it finds the first occurrence of a state that matches the specification in row "a". Move the cursor into the trigger field and press NEXT[], as required, to obtain [a].
- Move the cursor down into the ADDR5 field in row "a" and enter [TIME]+0011. Use the NEXT[] key to obtain [TIME] and the numeric keys to obtain +0011 as in figure 7-3.

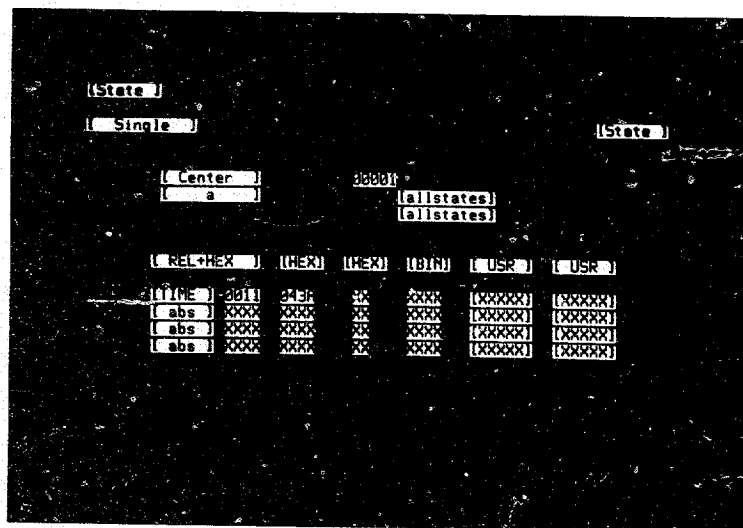

Figure 7-3. State Trace Specification In State/Timing Measurements

Executing Coordinated Measurements

1. Press the RUN key. The analyzer will find the state you specified as its trigger, and complete a state trace. If the analyzer does not find its state trigger (TIME+0011 on the 16 address lines of the address bus), the message "Waiting for State Trigger" will be on screen. In this case, press the STOP key. The message "Trace Aborted" will be on screen, along with a listing of the last eight transactions before you pressed the STOP key.
2. Write down one of the executions shown on the display under the ADDR5 label (such as TIME+001A).
3. Press the TRACE key.
4. Move the cursor down into the row "b" line.
5. Enter the module name and offset value from step 2 (use keyboard NEXT[] and hexadecimal keys). See figure 7-4.

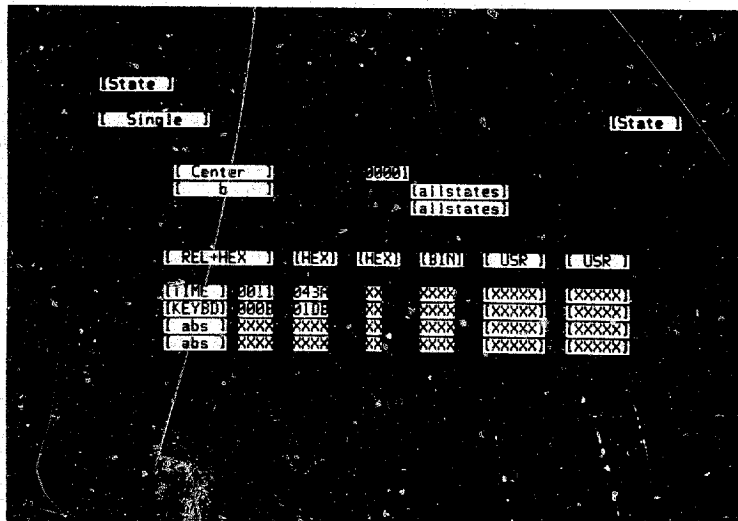

Figure 7-4. State Trace Specification With Trigger In Row "b"

6. Move the cursor up into the trigger field and press the NEXT[] key to change [a] to [b]. This sets the analyzer to trigger when it finds the state in row "b" (the state from step 2).
7. Press the RUN key. The analyzer will find the state specified as its trigger, and complete a state trace. It will show the message "Trace Complete" at the top of the display. The state selected as the trigger will be on line 0000.
8. Press the LIST key several times. Notice that pressing any of the INPUT DISPLAYS and OUTPUT DISPLAYS keys switches between the state analyzer and timing analyzer.
9. Press the FORMAT key. Press it a second time, if necessary, to place the [Timing] format specification on screen.
10. Check the display of the Activity line. If bit 2 in the timing pod shows no activity, connect bit 2 (the third line) from the timing probe to any active node in the target system.
11. Press the TRACE key. See figure 7-5.
12. Move the cursor into the Pattern field and enter a pattern of XXXX1X1X (with a binary display base).

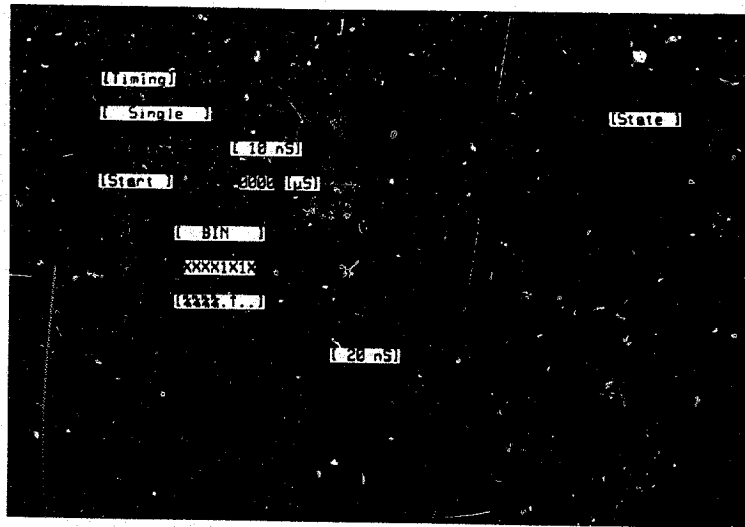

Figure 7-5. Timing Trace Specification For Combined State/Timing Measurements

13. Move the cursor down into the Edge field and use the NEXT[] key to enter a positive-going transition requirement (up arrow) for channel B2 (third from right-hand side) of the timing pod.
14. Press the RUN key. The state measurement in the analyzer will be completed as before. After the state trigger has been found, the timing function will search for the timing trigger. If it finds the timing trigger, it will complete its trace and show a waveform display. If it does not find its trigger, the analyzer will show the message "Waiting for Timing Trigger" on screen. In this case, press the STOP key. The message on screen will show "Trace Aborted". There will be waveforms displayed.
15. Press the LIST key two times. The trace list that was completed by the state measurement function will be displayed. It will show the state trigger on screen, along with other states it captured.
16. Press the TRACE key two times. This will place the trace specification for the timing function on screen.
17. Move the cursor down into the Pattern field and press and hold the DON'T CARE key until the field is all "X's". This can also be done by pressing CLEAR ENTRY. Now the timing analyzer trigger will be satisfied when the first low-to-high edge is found on channel 2 in pod 0.
18. Press the RUN key. The analyzer will search through the incoming states until it finds the state trigger. When it finds the state trigger, it will begin capturing states into memory, and at the same time, it will arm the timing analyzer to search for its trigger. The timing analyzer will monitor the incoming activity until it finds a rising edge on bit B2. Then it will store a series of samples of activity to complete its timing measurement. It will show "Trace Complete" on the top of the screen, and waveforms of timing information across the display. See figure 7-6.
19. Press the TRACE key. See figure 7-7.
20. Move the cursor into the "Master" field and press the NEXT[] key to change [State] to [Timing]. This makes the analyzer recognize its timing trigger before it can arm the state function to recognize the state trigger.
21. Press the RUN key. The analyzer will begin its measurement by looking for the condition that satisfies its timing trigger. When it finds this condition (rising edge on B2), it starts collecting timing information, and arms the state measurement function to look for its trigger. The timing analyzer displays its waveform information on screen while the state function completes its measurement.
22. Press the LIST key. The display will show a listing of the timing activity. See figure 7-8.

23. Press the LIST key again. The display will change to a listing of the information from the state analysis function.

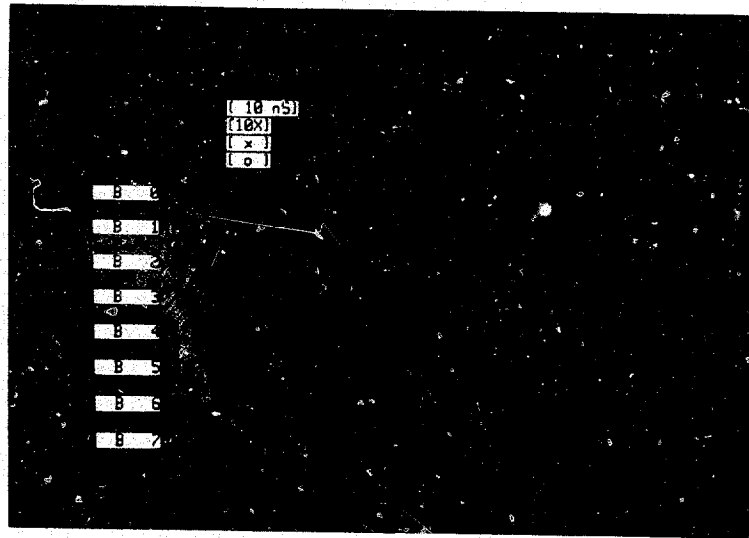

Figure 7-6. Timing Waveform Display

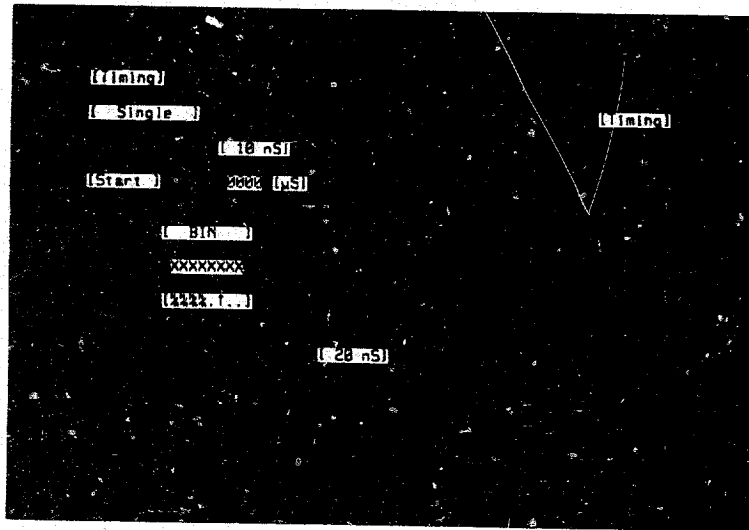

Figure 7-7. Timing Trace Specification With Master [Timing]

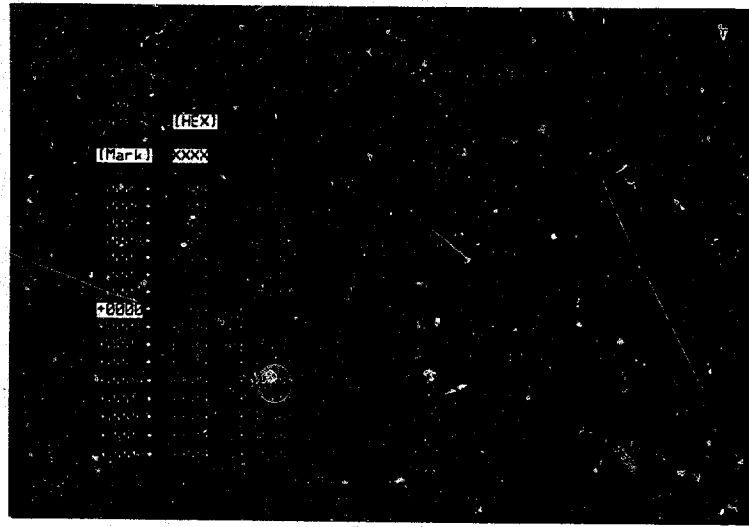

Figure 7-8. Timing Listing Display

Chapter 8. The Peripherals Menus

[Peripherals] System Configuration	8-1
1630A/D System [Peripherals] Specification Menu	8-1
1630G System [Peripherals] Specification Menu	8-2

Chapter 8

The Peripherals Menu

[PERIPHERALS] SYSTEM CONFIGURATION

In this menu, the way the analyzer will interact with peripherals through its interface connectors is set up. The analyzer clock and beeper are also set from this menu. The analyzer beeps at predetermined points in operation and when error conditions are detected. If desired, the beeper may be turned off. Figure 8-1 is the peripherals menu of the 1630A/D. Figures 8-2 and 8-3 are the peripherals menu of the 1630G. Figure 8-3 has messages and fields pertaining to inverse assemblers and configurations when they have been saved in internal storage. See Appendix D for more information on storage operations.

1630A/D System [Peripherals] Specification Menu

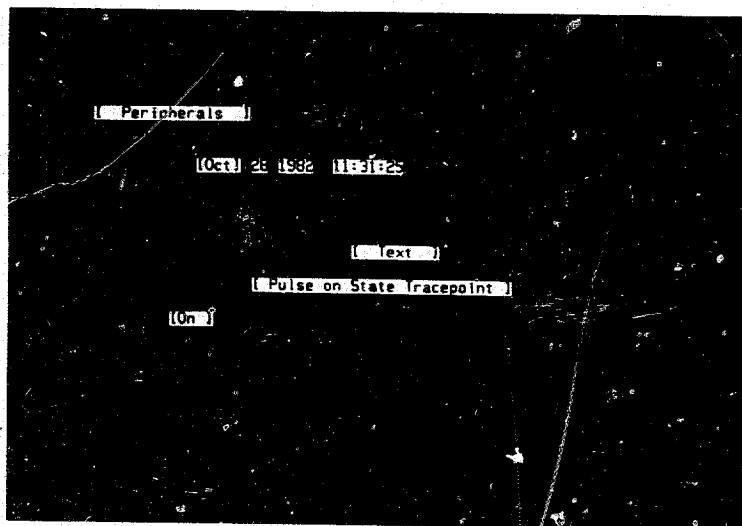

Figure 8-1. 1630A/D [Peripherals] System Specification

Clock Set:

Field used by analyzer to identify when information was captured into memory. Enter [month] day year hour:minute:second. Once set, this clock will continue to keep time as long as analyzer power is on.

Print Non-waveform Menus:

Selects code for information transfer to external printer.

[Text] selects information transfer using ASCII codes.

[Graphics] selects information transfer using HP-GRAPHICS codes.

Rear Panel Port:

Selects control signal to be supplied through the rear panel BNC output PORT to an external device, as follows:

[Pulse on State Tracepoint] - analyzer outputs 15-nsec TTL positive pulse when it finds state tracepoint.

[High til State Tracepoint] - after run start, analyzer outputs TTL high until it finds state tracepoint. Then it switches TTL low.

[Low til State Tracepoint] - after run start, analyzer outputs TTL low until it finds state tracepoint. Then it switches TTL high.

[High on Last Sequence] - analyzer outputs TTL high when it is searching for the last term in a trigger sequence.

[High on Timing Pattern] - analyzer outputs TTL high as long as the timing trigger pattern occurs for longer than the specified valid pattern duration.

[Constant High] - analyzer outputs TTL high.

Beeper:

when **[On]**, the analyzer will beep whenever it completes a measurement, and whenever it flashes an error or warning message on screen. When **[Off]**, the analyzer will not beep at any time.

1630G System [Peripherals] Specification Menu

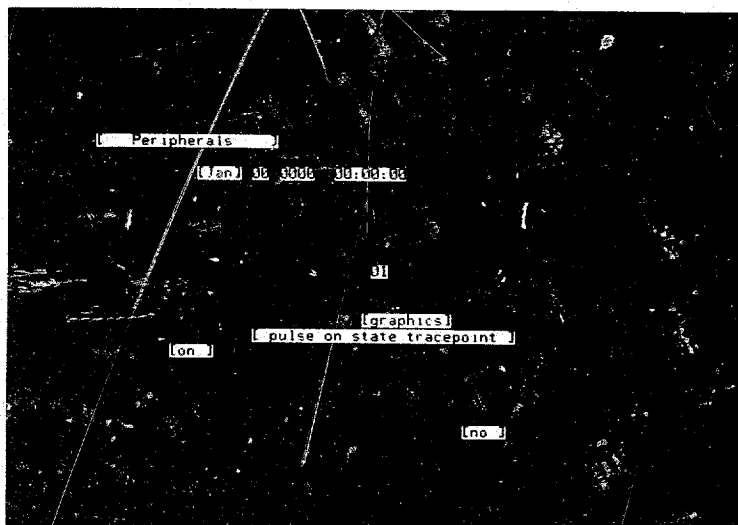

Figure 8-2. 1630G System [Peripherals] Specification Menu Without Internally Stored Information

Clock Set:

field used by analyzer to identify when information is captured into memory or stored on the disc. Enter **[month] day year hour:minute:second**. Once set, this clock will continue to keep time as long as analyzer power is on. Once any entry is made in the clock set field, the entire setting must be properly made.

HP-IL:

HP-IB:

these are controlled by the configuration switches 7 and 8 (the rightmost switches when looking at the rear panel of the 1630. If the switch configuration is 00, then the messages are as follows:

HP-IL: Inactive

HP-IB: 1630G is controller

If the switch configuration is 01, then the messages are as follows:

HP-IL: Inactive

HP-IB: External Controller

If the switch configuration is 10, then the messages are as follows:

HP-IL: External Controller

HP-IB: 1630G is controller

Logic Analyzer HP-IB Address:

displays the two-digit HP-IB address that is set by the configuration switches 1 through 6.

Printer HP-IB Address: defaults to 01, however can be manually set to any number between 00 and 30 if no other instrument is assigned to that address. If the logic analyzer is set to address 01, then the printer address defaults to 02.

Disc HP-IB Address: defaults to the lowest available HP-IB address (i.e., defaults to 2 if logic analyzer is address 0; otherwise will be at address 0).

Print Non-Waveform Menus In:

Selects code for information transfer to external printer.

[Text] selects information transfer using ASCII codes.

[Graphics] selects information transfer using HP-GRAPHICS codes.

NOTE

Waveform chart menus are always transmitted in HP-GRAPHICS code.

Rear Panel Port:

selects control signal to be supplied through the rear panel BNC output PORT to an external device, as follows:

[Pulse on State Tracepoint] - analyzer outputs 15 nsec TTL positive pulse when it finds state tracepoint.

[High until State Tracepoint] - after run start, analyzer outputs TTL high until it finds state tracepoint. Then it switches TTL low.

[Low until State Tracepoint] - after run start, analyzer outputs TTL low until it finds state tracepoint. Then it switches TTL high.

[High on Last Sequence] - analyzer outputs TTL high when it is searching for the last term in a trigger sequence.

[Constant High] - analyzer outputs TTL high.

[Constant Low] - analyzer outputs TTL low.

Beeper:

when [On], the analyzer will beep whenever it completes a measurement, and whenever it flashes an error or warning message on screen. When [Off], the analyzer will not beep at any time.

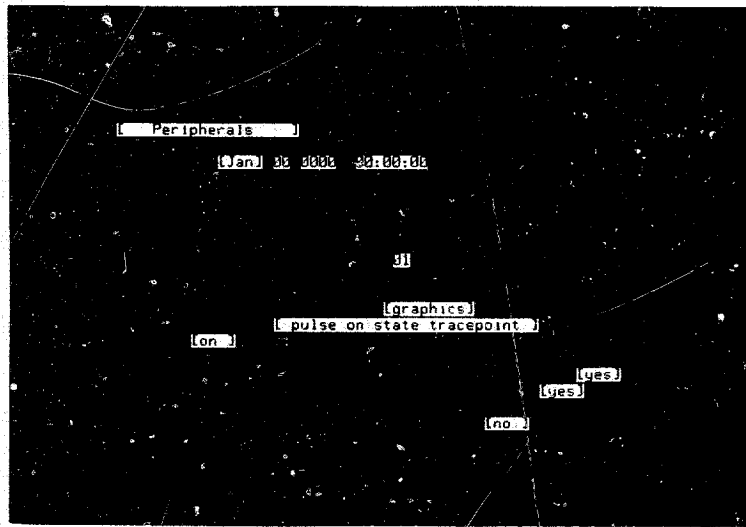

Figure 8-3. 1630G System [Peripherals] Specification Menu
With Internally Stored Information

Autoload Inverse Assembler From Internal Storage:

using the PREV[], NEXT[] keys can be toggled between [yes] and [no]. Anytime the selection to [yes] is made the inverse assembler that is stored in memory is loaded to be active. If [yes] is selected the inverse assembler is automatically loaded the next time the instrument is powered up.

Autoload Configuration From Internal Storage:

using the PREV[], NEXT[] keys can be toggled between [yes] and [no]. Anytime the selection to [yes] is made the previously stored configuration in memory is loaded to be active. If [yes] is selected the configuration is automatically loaded the next time the instrument is powered up.

NOTE

If "Autoload inverse assembler from internal storage" and "Autoload configuration from internal storage" are both set to [yes] at power up, the inverse is loaded and then the configuration is loaded. If the configuration does not contain the same format specification as the inverse assembler, the inverse assembler may not function properly.

Save Configuration In Internal Storage:

using the PREV[], NEXT[] keys [yes] can be selected, at which time the current configuration is stored in internal storage, then the selection returns to [no].

If the internal storage is not operating properly when power is applied or when it is attempted to save a configuration in internal storage, the message "Internal storage failed power-up" will replace the peripherals menu entries "Autoload inverse assembler from internal storage" and "Autoload configuration from internal storage". The peripherals menu entry "Save configuration in internal storage" will still be displayed. If [yes] is selected, a reset will be attempted on the internal storage before configuration storage commences. During the reset, the message "WAIT resetting internal storage" will be displayed. If the reset fails, the message "Internal storage failed power-up" will remain on-screen. If the reset is successful, the current configuration will be saved in internal storage. The "Internal storage failed power-up" message will be replaced with "Autoload configuration from internal storage".

Chapter 9. Using HP-IB Or HP-IL Interface

Introduction	9-1
HP-IB and HP-IL Interface Capabilities	9-1
Keyboard Mnemonics	9-2
Data Formats	9-5
Data Formatting Examples	9-6
HP 1630A/D Learn String Commands	9-10
TC - Transmit Configuration Learn String	9-10
TS - Transmit State Acquisition Learn String	9-10
TT - Transmit Timing Acquisition Learn String	9-14
TE - Transmit Everything Learn String	9-15
Data Transfer Termination	9-15
HP 1630G Learn String Commands	9-15
TC - Transmit Configuration Learn String	9-15
TS - Transmit State Acquisition Learn String	9-16
TT - Transmit Timing Acquisition Learn String	9-21
TE - Transmit Everything Learn String	9-22
Data Transfer Termination	9-22

Chapter 9

Using HP-IB or HP-IL Interface

INTRODUCTION

This chapter contains programming instructions for operating the analyzer via HP-IB or HP-IL interfaces. The HP-IB and HP-IL interface capabilities and device-dependent commands are identical. All operations that can be obtained by pressing a front-panel key can also be obtained by using the analyzer device-dependent commands when they are sent over an HP-IB or HP-IL interface from a controller. This chapter provides detailed information about each of the device-dependent commands and how these commands affect the analyzer. The command learn strings of the HP 1630A/D and the HP 1630G are different because the 1630A/D uses HP-IL mass storage and the 1630G uses HP-IB mass storage. Two sections are provided in this chapter to differentiate the command sets.

HP-IB AND HP-IL INTERFACE CAPABILITIES

The following HP-IB and HP-IL interface functions are implemented in the analyzer.

SERVICE REQUEST (SRQ) - Programmable service request for various conditions specified in the Mask Byte (MB) command. Reset when status byte read by SERIAL POLL or via SB command.

SERIAL POLLING - The serial poll represents the unmasked status of the machine and is identical to the SB1 response. Status bits are unmasked using the Mask Byte (MB) command. Serial polling is the preferred method of checking machine status because serial polling will not cause the analyzer to abort any currently pending output. The "SB" command does cause such aborts.

PARALLEL POLLING - Complete parallel polling capability. Sense bit of ENABLE message is used to determine whether a service request is indicated by a 1 or 0 on the specified bit. Request is cleared by a serial poll or by sending SB1.

GROUP EXECUTE TRIGGER - Executes a measurement similar to pressing the RUN key.

REMOTE/LOCAL/LOCAL LOCKOUT - Complete capability.

INTERFACE CLEAR - Clears the interface to an untalk/unlisten state.

DEVICE CLEAR - Aborts any interface operation and clears input/output buffers.

The analyzer will abort any pending output if it receives a new command from the controller before it has been addressed to send its output. For example, if the controller commands a menu change in the analyzer before it addressed the analyzer to talk, the analyzer will abort its status byte message.

KEYBOARD MNEMONICS

The device-dependent commands for keyboard functions are implemented in a mnemonic-per-keystroke format. Table 9-1 lists the HP-IB and HP-IL command mnemonic for each key. Any key mnemonic can be followed by an ASCII number that indicates how many times to repeat that key. For example "CD5" will cause the "Cursor Down" command to be executed five times. Sending the command "NX 10" is the same as pressing the NEXT key ten times.

To send data keys (i.e., numeric 0123456789ABCDEFX or alphabetic values) enclose the ASCII representations of those keys in field delimiters. For example, if a pattern is to be sent after positioning the cursor to a particular field, send the pattern in field delimiters, i.e., OUTPUT 700; "(01XX1533)". Three different field delimiters are allowed: ",", and (). Use the same delimiter at the start and end of a field. Mnemonics can be sent using either upper case or lower case letters. Commands must be delimited by one or more of the

delimiting characters: semicolon (;), carriage return (cr), or linefeed (lf). When any of the delimiting characters are encountered, following a command, the command will be transmitted. More than one delimiter may be used in a string, however, any one will cause the command to be transmitted. The following examples all cause the command (TC) to be transmitted: TC;, TCcr, TClf, TC;crlf.

Table 9-1. HP-IB/HP-IL Keyboard Mnemonics

Key	Mnemonic	Key	Mnemonic
SYSTEM menu	SM	INSERT	IN
FORMAT menu	FM	DELETE	DE
TRACE menu	TM		
LIST menu	LM	CLEAR ENTRY	CE
WFORM menu	WM	DEFAULT	DM
CURSOR left	CL	NEXT[]	NX
CURSOR right	CR	PREV[]	PV
CURSOR up	CU	DON'T CARE	
CURSOR down	CD		
LABEL left	LL	RUN	RN
LABEL right	LR	RESUME	RE
LABEL up	LU	STOP	ST
LABEL down	LD	PRINT	PR
		PRINT ALL	PA
ROLL down	RD		
ROLL up	RU		
ROLL left	RL		
ROLL right	RR		

NON-KEYBOARD MNEMONICS

The following HP-IB and HP-IL mnemonics command the analyzer to take actions that are not possible from the keyboard.

BP — Beep. Sounds analyzer beeper.

SYNTAX: BP;

CH -- Cursor Home. Moves cursor to known location at upper leftmost field of analyzer display.

SYNTAX: CH;

DB — Display Blank. Clears analyzer display. For proper operation, the SYSTEM [Configuration] menu should be on the display when you issue the "DB" command. The word "REMOTE" will not disappear from the display. If a trace is in process, the message area of the screen may be asynchronously updated.

SYNTAX: DB;

DR — Display Read. Command causes analyzer to read from display memory, starting from specified row and column, specified number of characters for transfer to HP-IB/HP-IL interface followed by CR l.f. Inverse video characters are sent as the ASCII character value plus 128.

SYNTAX: DR <ROW><COL><BYTE__COUNT>;

where BYTE__COUNT has a maximum integer value of 1472 (23 rows × 64 columns)

ROW is integer value with range of 1 to 23

COL is integer value with range of 1 to 64

DW — Display Write. Writes ASCII string of 80 or less characters to analyzer display, beginning at position specified by row and column.

SYNTAX: DW[I] <ROW><COL> (STRING);

where I is optional parameter specifying that string be displayed in inverse video.

Legal delimiters for STRING are “,” and ().

ID — Send Identification code. Causes analyzer to send identification code indicating instrument configuration followed by CR LF.

SYNTAX: ID;

where returned value is a string containing the instrument model number (“HP1630A”, “HP1630D” or “1630G”).

HP1630A - (35-channel state, 8 timing)

HP1630D - (43-channel state, 16 timing)

HP1630G - (57-channel state, 8 timing)

KE — Send buffered key. Causes analyzer to send key mnemonic or alphanumeric character followed by CR LF for any key (refer to table 9-1) that has been pressed while in remote mode. Buffer saves up to the last 15 key presses. If no keys have been pressed, the analyzer returns double question marks (??).

SYNTAX: KE;

MB — Set service request mask byte. Enables SRQ, PP response, and bits in the serial poll and SB1 registers specified in argument. Mask byte is set to 0 at power-on, disabling any service requests.

SYNTAX: MB <mask __value>;

where mask __value is an ASCII integer (i.e., 0 to 255) in decimal format. A service request (SRQ) will be generated if the mask bit for a condition is set to one and that condition occurs. The mask bit positions are:

Bit 0 (1) = Print Complete

Bit 1 (2) = Measurement Complete

Bit 2 (4) = Slow Clock

Bit 3 (8) = Key Pressed (Front Panel Request)

Bit 4 (16) = Not Busy

Bit 5 (32) = Error in Last Command

PU — Power-up. Defaults all instrument menus. Buffered keys, SRQ, PP and status bytes are unmodified.

SYNTAX: PU;

RST — Reset. Reset analyzer to power-up condition as if power was cycled. A one second delay is recommended after RST prior to sending any other remote commands.

SB — Status Byte. Returns analyzer status byte to controller on next read. One of four status bytes may be requested. Status bytes are returned as a single byte without termination. The character decimal value returned represents the status.

SYNTAX: SB N;

where N is an integer value from 1 to 4. If argument N is omitted, the default condition is status byte 1. Requesting status byte 1 or executing a serial poll resets the SRQ and PP response and clears the bits in the serial poll or SB1 register.

Status Byte 1 - Machine status (of bits currently enabled by Service Request Mask Byte).

- Bit 0 (1) = Print Complete
- Bit 1 (2) = Measurement Complete
- Bit 2 (4) = Slow Clock
- Bit 3 (8) = Key Pressed (Front Panel Request)
- Bit 4 (16) = Not Busy
- Bit 5 (32) = Error in Last Command
- Bit 6 (64) = Reserved for indicating Service Request

Status Byte 2 - Machine status of all bits regardless of the service request mask byte. These bits are cleared when the condition causing the bit to be set is cleared.

Same as status byte 1.

Status Byte 3 - Trace status consisting of the service request mask byte. Status is cleared on trace in progress. Q2 represents bits B4 through B7. Q1 represents bits B0 through B3.

- | | |
|---|--|
| <ul style="list-style-type: none"> Q2 = 0 - No Trace Taken 1 - Trace in Progress 2 - Measurement Complete 3 - Measurement Aborted | <ul style="list-style-type: none"> Q1 = 0 - Not Active (no measurement in progress) 1 - Waiting for State Trigger Term 2 - Waiting for Sequence Term #1 3 - Waiting for Sequence Term #2 4 - Waiting for Sequence Term #3 5 - Waiting for Time Interval End Term 6 - Waiting for Time Interval Start Term 7 - Slow Clock 8 - Waiting for Timing Trigger 9 - Delaying Timing Trace 10 - Timing Trace in Progress |
|---|--|

Status byte 4 - Controller error codes indicating error condition or action required from controller.

Error Code =

- | | |
|---|--|
| <ul style="list-style-type: none"> 4 - value not allowed 8 - use NEXT[] PREV[] keys 9 - numeric entry required 10 - use hex keys 11 - use alphanumeric keys 13 - requires correction first 15 - DON'T CARE not allowed 16 - use 0 or 1 17 - use 0, 1, or DON'T CARE 18 - use 0 thru 7 19 - use 0 thru 7 or DON'T CARE 20 - use 0 thru 3 21 - use 0 thru 3 or DON'T CARE 22 - value is too large 24 - use CHS key | <ul style="list-style-type: none"> 30 - maximum INSERTs used 40 - disc contains non-HP1630 data 41 - CRC does not match 47 - illegal name file 48 - duplicate HP-IB address 49 - reload disc first 50 - storage operation aborted 51 - file not found 58 - in controller command 60 - write protected disc 61 - RESUME not allowed 62 - invalid in this trace mode 82 - incorrect revision code |
|---|--|

LEARN STRING COMMANDS

The following learn string commands instruct the analyzer to transmit its internal configuration, state acquisition data, and/or timing acquisition data to the controller. Learn string commands provide a means of saving configurations and acquisition data for later use and analysis. Measurement configurations can be stored and reloaded to repeat complex measurements. Likewise, acquisition data can be returned to the analyzer for analysis at a more convenient time. You need only transmit the learn string back to the analyzer to restore configuration or an acquisition. The learn string is transmitted as a receive learn string, that is, nothing need be added or changed in the learn string in order to return it to the logic analyzer.

Each learn string contains the proper mnemonic header (RS, RT, RA) to receive state or timing data, a binary byte-count word, the binary data, and two Cyclic Redundancy Check (CRC) bytes. The binary byte-count word, returned most significant byte (MSB) first and least significant byte (LSB) last, gives the number of bytes contained in the binary data file, including the two CRC bytes but not the byte count word or the mnemonic.

Data Formats

Real data is transmitted in one of the following formats. The format type is indicated by abbreviation in the syntax contents column for each learn string.

- (A) - ASCII data
- (B) - BCD (binary coded decimal) data
- (I) - Integer data (if multi-byte MSB first, LSB last)
- (R) - Real data (in floating point decimal format)
- (S) - Switch (Boolean data) 0=False, ≠0 (not 0)=True

(T) - Time	Byte 0	Byte 1
	0 - 1	0 - ns
	1 - 2	1 - us
	2 - 5	2 - ms
	3 - 10	
	4 - 20	
	5 - 50	
	6 - 100	
	7 - 200	
	8 - 500	

- (W) - Wide special nine byte internal structure in 1630G.
- Wide special six byte internal structure in 1630A/D.

Date/Time information

Each of the learn strings contain month, day and time information. This data is formatted as follows:

- Month - (I) defined using one byte and is an integer value 0 through 11 where 0 = January, 1 = February, etc.
- Day - (B) defined using one byte containing two BCD digits.
- Hour - (B) defined using one byte containing two padded BCD digits.
- Minute - (B) defined using one byte containing two padded BCD digits.
- Second - (B) defined using one byte containing two padded BCD digits.
- Year - (I) defined using two bytes representing one 16 bit integer transmitted as MSB first and LSB last.

All data that contains more than one byte in the string is transmitted MSB first and LSB last.

Data Formatting Examples

The following examples are intended to demonstrate decoding of various learn string bytes that are coded in different formats. The bytes are sent from the logic analyzer over the HP-IL cable or the HP-IB bus. These examples assume HP-IB use with an HP Series 200 controller with Basic 2.0 Language Operating System.

ASCII (A) Format

ASCII format is used at various points in many of the logic analyzer learn strings. One usage of the ASCII format is in the State Label Overview Learn String. The last five bytes in each 23 byte interval range represent the state label name formatted in ASCII.

When the following commands are sent from a Series 200 controller to the logic analyzer, the State Label Overview Learn String will be received by the controller. (This example assumes the logic analyzer is in the State Label Overview trace mode and has completed an acquisition.)

```
Output @Logic__analyzer using "#, K";"TS;"
Enter @Logic__analyzer using "%,-K";S$
```

Byte positions 40-44 are the bytes when translated to ASCII and then alpha characters give the name of the first state label range (a total of eight characters are allowed). For instance, if the first range name is "DELAY", bytes 40-44 would be represented:

Parameter:	State assignment label name (State Label Overview Learn String)				
Byte Position:	Byte 40	Byte 41	Byte 42	Byte 43	Byte 44
ASCII:	D	E	L	A	Y
Hexadecimal:	44	45	4C	41	59
Decimal:	68	69	76	65	89

Binary Coded Decimal (B)/Integer (I) Formats

The most common usage of the binary coded decimal and integer formats is the encoding of the Date/Time settings. The precise byte positions of these parameters within the particular learn string is in the learn string listing. The interpretation of this information is given in the following example. The byte positions are from a State Trace Learn String which are bytes 5 through 11 in the learn string. The Date/Time is August 28, 1985 at 10:50:07.

Parameter:	Month	Day	Hour	Min.	Second	Year	Year
Byte Position:	5	6	7	8	9	11	11
Format:	(B)	(B)	(B)	(B)	(B)	(I)	(I)
Hexadecimal:	07	28	10	50	07	07	C1

Interpreting the hexadecimal representations for month, day, hour, and second are straightforward. The month is represented from 0 to 11 as described for month in Date/Time Information previously in this chapter. However, the integer decoding for the year is not as apparent. It can be regarded as having the MSB (most significant byte) coming first as follows:

Byte Position:	Byte 10		Byte 11	
Hexadecimal:	0	7	C	1
Binary:	0000	0111	1100	0001
	16 ³	16 ²	16 ¹	16 ⁰

$$(7 \times 16^2) + (12 \times 16^1) + (1 \times 16^0) = 1985$$

Real Data (R) Format

Data that is structured using the floating point system is indicated with the abbreviation (R) in the contents column of the learn string. The floating point format used in the learn strings consists of 32 bits as shown in the following arrangement.



Where:

EEEEEEE = 7-bit 2's Complement Power of 2

S = Sign of Mantissa (0=Positive, 1=Negative)

M.....M = 24-bit Unsigned Mantissa (Fraction)

NOTE

When acquisition is timing trace, this number refers to number of marks or number of sample period intervals.

The floating point format is an efficient method of representing large numbers using minimum memory space. The interpretation of a particular parameter using real format is dependent on the context of the parameter. A real number for a parameter involving "time" must be multiplied by a standard time increment which is peculiar to that learn string. An example is in the Timing Trace learn string where the real numbers obtained must be multiplied by the sample period to obtain the proper time. However, in the State Time Interval Overview Learn String, the number obtained is always in seconds which is essentially the same as multiplying by one.

In a case where a parameter does not involve time, the decoded real number is directly translatable. This is evident in the Timing Trace Learn String parameter for the number of marks or runs.

The following example is from a State Time Interval Learn String. A run was made which acquired a total of 76 samples in 145.5 μ sec.

Parameter:	Total Number of States			
Byte Position:	14	15	16	17
Format:	(R)	(R)	(R)	(R)
Hexadecimal:	0E	98	00	00

The first byte (byte 14) is the exponent and is decoded as:

Hexadecimal:	0	E	
Binary:	0000	1110	└── indicates positive number
(EXPONENT):	0000	0111	
	0	7	└── indicates binary power of 2 ⁷

The least significant bit in binary representation of the byte indicates the number is positive. The remaining seven bits are then considered a separate binary number which, in this case equals seven. There are two ways to interpret remainder of the number (bytes 15 through 17).

The first way to interpret the remaining number is to use the floating point translation which can be generalized as:

$$(MANTISSA) \times 2^{(EXPONENT)}$$

(The mantissa is always a fraction less than one.)

In this case, the binary point is assumed left of byte 15. The mantissa could then be represented in decimal as follows:

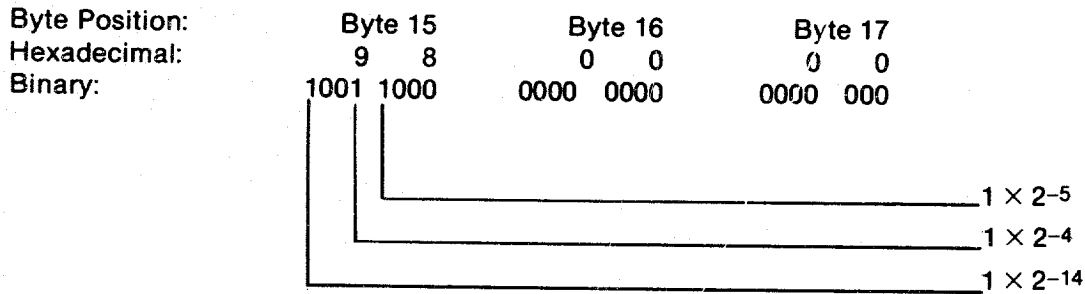

Decimal: $(1 \times 2^{-14}) + (1 \times 2^{-4}) + (1 \times 2^{-5}) = .594 = (MANTISSA)$

Therefore, the equation $(MANTISSA) \times 2^{(EXPONENT)}$ reveals:

$$(.594) \times 2^{(7)} = 76 \text{ runs}$$

Another method of decoding this number is to move the binary point to the right the same number of places as the exponent indicates. Then, interpret the binary number directly as a number greater than one as indicated below.

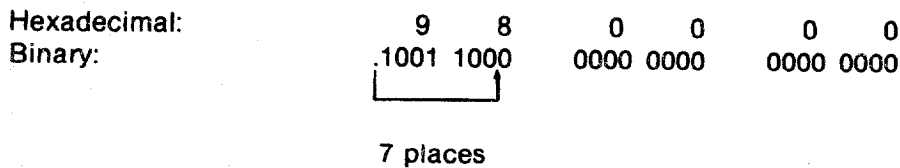

$$1001100 = 64 + 8 + 4 = 76 \text{ runs}$$

The exponent is a 7-bit 2's complement number, therefore, positive value exponents are not required to be converted to normal binary since they are the same. However, a negative exponent value must first be translated to normal binary representation before interpreting the exponent as a negative number.

The following example of the State Time Interval Overview Learn String parameter for Total Time demonstrates a negative value exponent.

Parameter:	Total Accumulated Time (State Time Interval Overview Learn String)			
Byte Position:	18	19	20	21
Format:	(R)	(R)	(R)	(R)
Hexadecimal:	E8	98	91	5E

Referring to the real format arrangement example, byte 18 is the exponent byte. Byte 18 is decoded as:

Hexidecimal:	E	8	
Binary:	1110	1000	
			indicates number is positive
			indicates exponent is negative
7-bit 2's complement:	111	0100	
Invert:	000	1011	
Add one:	+1		
Exponent:	0001	1100 = -12	

Since the binary point is to the left of byte 19, the first place to the right is 2-13. The rest of the number (bytes 19 through 21) can be translated as follows:

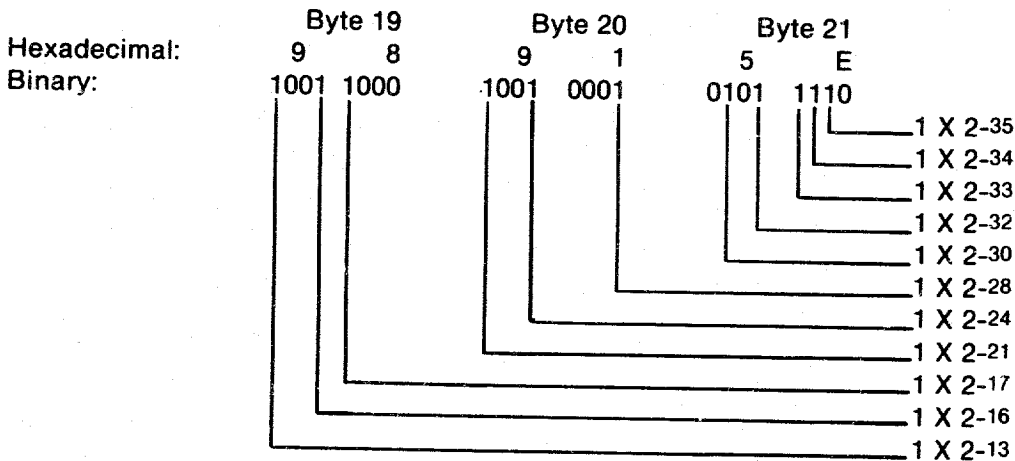

The sum of the entire column to the right is 145.44 μ sec total accumulated time.

Time (T) Format

Another example involving the Timing Trace Learn String illustrates the prior discussion pertaining to multiplication by a standard time increment. In this example, the timing trace was acquired with a 10 nsec sample period with a mean time between the x and o cursors of 1.52 μ sec.

Parameter:	Sample Period (Timing Trace Learn String)	
Byte Position:	11	12
Format:	(T)	(T)
Hexadecimal:	03	00

From the listing for time in the Data Format section of this chapter, this translates to 10 nsec.

Parameter:	Mean Time Between Cursors (Timing Trace Learn String)			
Byte Position:	24	25	26	27
Format:	(R)	(R)	(R)	(R)
Hexadecimal:	1 0	9 8	9 4	7 B
Binary:	0001 0000	1001 1000	1001 0010	0111 1011

1001 1000 = 128 + 16 + 8 = 152

At 10 nsec: 152 X 10 nsec = 1.52 usec mean time between cursors.

HP 1630A/D LEARN STRING COMMANDS

TC - Transmit Configuration Learn String

The Transmit Configuration Learn String command causes the 1630A/D analyzer to transmit a string containing its configuration data plus two CRC bytes.

SYNTAX: TC;

Learn String Format:

Starting Position In String	Byte Number Of Bytes	Contents
1	2	(A) RC (Receive Configuration Command)
3	2	(I) Binary byte count (refer to Note)
5	4284	CRC STARTS ACCUMULATING WITH NEXT BYTE () Configuration Data
4287	2	CRC STOPPED ACCUMULATING WITH PREVIOUS BYTE (I) CRC bytes

NOTE

The binary value of these bytes is the number of bytes to follow including the CRC bytes. This value is transmitted as MSB first and LSB last. The number of bytes transmitted is 4284.

TS - Transmit State Acquisition Learn String

The Transmit State Acquisition Learn String command causes the 1630A/D analyzer to transmit a string containing its state measurement data plus two CRC bytes. The measurement data consists of state trace data, state label overview data, or time interval overview data.

The actual state data (trace, label overview, or time interval) is transmitted in the following manner. The first five bits of the MSB is internal. The three least significant bits of the MSB correspond to data from Pod 4 bit 8, etc., as shown below.

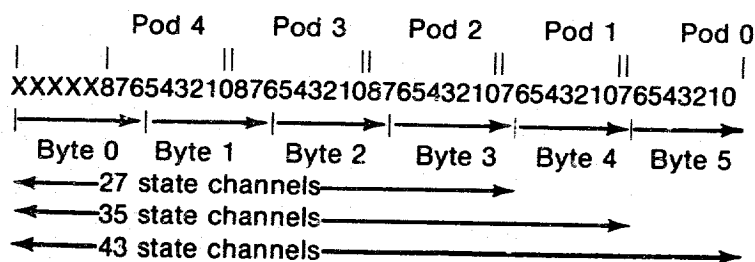

There are four bytes per state for 27 state channel data, five bytes per state for 35 state channel data, and six bytes for 43 state channel data.

HP 1630A/D Learn String Format (for State Trace Data):

SYNTAX: TS;

<u>Starting Byte Position In String</u>	<u>Number Of Bytes</u>	<u>Contents</u>
1	2	(A) RS (Receive State Command)
3	2	(I) Binary byte count (refer to Note) CRC STARTS ACCUMULATING WITH NEXT BYTE
5	7	(I,B) Date/Time information
12	1	Internal
13	1	(I) Type of Data (0 = State Trace Data)
14	1	(I) Number of state channels
15	2	(I) Number of valid states captured
17	2	(I) State Trace Point
19	N	(I) Data Acquired N = (Number of Valid States) * M
		Where: M = 0 if no state channels. M = 4 if 27 state channels. M = 5 if 35 state channels. M = 6 if 43 state channels.
N + 19	2	CRC STOPPED ACCUMULATING WITH PREVIOUS BYTE (I) CRC

Note

The binary value of these bytes is the number of bytes to follow including the CRC bytes. This value is transmitted as MSB first and LSB last. The maximum number of bytes that can be transmitted is 4111 for 27 channels and 5135 for 35 channels.

HP 1630A/D Learn String Format (for State Label Overview)

SYNTAX: TS;

<u>Starting Byte Position In String</u>	<u>Number Of Bytes</u>	<u>Contents</u>
1	2	(A) RS (Receive State Command)
3	2	(I) Binary byte count (refer to Note) CRC STARTS ACCUMULATING WITH NEXT BYTE
5	7	(I,B) Date/Time information
12	1	(I) Type of Data (1 = State Label Overview)
13	8	Internal
21	184	(I) Data acquired from 8 state label ranges- fewer bytes if less than 8 ranges
		Each state label range contains:
	2	Internal
	4	(R) Number of samples in this range
	6	(W) End address of this range
	6	(W) Start address of this range
	5	(A) The five character name of this range
205	5	(A) State assignment label (ADDRS, STAT, etc.)
210	6	Internal
226	4	(R) Total number of samples taken (excluding "Other" bucket)
220	4	(R) Number of samples in "Other" bucket
222	2	CRC STOPPED ACCUMULATING WITH PREVIOUS BYTE (I) CRC

NOTE

The binary value of these bytes is the number of bytes to follow including the CRC bytes. This value is transmitted as MSB first and LSB last. The maximum byte count is 154.

HP 1630A/D Learn String Format (for Time Interval Overview)

SYNTAX: TS;

<u>Starting Byte Position In String</u>	<u>Number Of Bytes</u>	<u>Contents</u>
1	2	(A) RS (Receive State Command)
3	2	(I) Binary byte count (refer to Note)
5	7	CRC STARTS ACCUMULATING WITH NEXT BYTE
12	1	(I,B) Date/Time information
13	4	(I) Type of Data (2 = State Time Interval)
17	4	(R) Total Number of States
21	4	(R) Total Accumulated Time
25	4	(R) Minimum interval found
29	4	(R) Maximum interval found
33	4	(R) Average time of interval
37	8	(R) Time of last interval acquired
45	112	Internal (I) Data acquired from 8 time interval ranges- fewer bytes if less than 8 ranges
2		Each time interval range contains:
4		Internal
4		(R) Number of samples in this range
4		(R) End time of this range
4		(R) Start time of this range
157	2	(I) CRC

NOTE

The binary value of these bytes is the number of bytes to follow including the CRC check bytes. This value is transmitted as MSB first and LSB last. The maximum byte count is 154.

TT - Transmit Timing Acquisition Learn String

The transmit timing acquisition learn string command causes the analyzer to transmit a string containing its timing measurement data plus two CRC bytes. Glitch information will also be transmitted if the analyzer is in the glitch mode of operation.

The actual timing data is transmitted as in the following manner:

1 byte per record for 8 timing channels
2 bytes per record for 16 timing channels

```

| Pod 1 || Pod 0 |
7654321076543210
|       ||       |
| Byte0 || Byte 1 |
|       || 8 Chan |
|       || 16 Chan |

```

When the contents of the acquisition is formatted as real data (R), the number refers to number of marks or number of sample period intervals.

HP 1630A/D Learn String Format (for Timing Trace)

SYNTAX: TT;

<u>Starting Byte Position In String</u>	<u>Number Of Bytes</u>	<u>Contents</u>
1	2	RT (Receive Timing Command)
3	2	(I) Binary byte count (refer to Note)
5	1	CRC STARTS ACCUMULATING WITH NEXT BYTE
6	1	(I) Number of timing channels
8	2	(I) Number of valid timing states
10	2	(I) Index of the tracepoint state
11	1	(S) Glitch mode on
13	2	(T) Sample period
13	7	(I,B) Date/Time information
20	N	(I) Data File
		Where N = (Number of records) * M
		M = 1 byte per record for 8 channels
		M = 2 bytes per record for 16 channels
N + 21	2	CRC STOPPED ACCUMULATING WITH PREVIOUS BYTE
		(I) CRC

Note

The binary value of these bytes is the number of bytes to follow including the CRC bytes. The maximum binary number, if the memory is full, is 2065 for 16 channels and 1041 for 8 channels.

With partial memories, the binary value of these bytes will include the last word in memory plus two CRC bytes.

TE - Transmit Everything Learn String

The transmit everything learn string command instructs the analyzer to transmit the following data in the listed sequence: (1) configuration learn string, (2) state data acquisition learn string, and (3) timing data acquisition learn string. Refer to the TC, TS, and TT command descriptions for learn string formats. The maximum number of bytes will be the sum of the bytes of the individual commands. The maximum number of bytes (4284) will occur in the combined State/Timing Mode.

DATA TRANSFER TERMINATION

Binary transfers of data are terminated by setting EOI true with the last byte transferred. Non-binary transfers are terminated by sending CR LF with EOI true.

HP1630G LEARN STRING COMMANDS

TC - Transmit Configuration Learn String

The transmit configuration learn string command causes the HP 1630G analyzer to transmit a string containing its configuration data plus two CRC bytes.

HP 1630G Learn String Format for Transmit Configuration

SYNTAX: TC;

<u>Starting Byte Position In String</u>	<u>Number Of Bytes</u>	<u>Contents</u>
1	2	(A) RC (Receive Configuration Command)
3	2	(I) Binary byte count (refer to Note)
5	5476	CRC STARTS ACCUMULATING WITH NEXT BYTE Configuration Data
5476	1	CRC STOPPED ACCUMULATING WITH PREVIOUS BYTE Revision Code
5477	2	(I) CRC bytes

NOTE

The binary value of these bytes is the number of bytes to follow including the CRC bytes. This value is transmitted as MSB first and LSB last. The number of bytes transmitted is 5476.

TS - Transmit State Acquisition Learn String

The transmit state acquisition learn string command causes the HP 1630G analyzer to transmit a string containing its state measurement data plus two CRC bytes. The measurement data consists of state trace data, state label overview data, time interval overview data, time positional data, or linkage overview data.

The actual state data (trace, label overview, time interval, time positional, or linkage overview) is transmitted in the following manner. The first seven bits of the MSB are internal. The last two least significant bits of the MSB correspond to data from Pod 7 bit 9, etc., as shown below.

TS - Transmit State Acquisition Learn String

The transmit state acquisition learn string command causes the HP 1630G analyzer to transmit a string containing its state measurement data plus two CRC bytes. The measurement data consists of state trace data, state label overview data, time interval overview data, time positional data, or linkage overview data.

The actual state data (trace, label overview, time interval, time positional, or linkage overview) is transmitted in the following manner. The first seven bits of the MSB are internal. The last two least significant bits of the MSB correspond to data from Pod 7 bit 9, etc., as shown below.

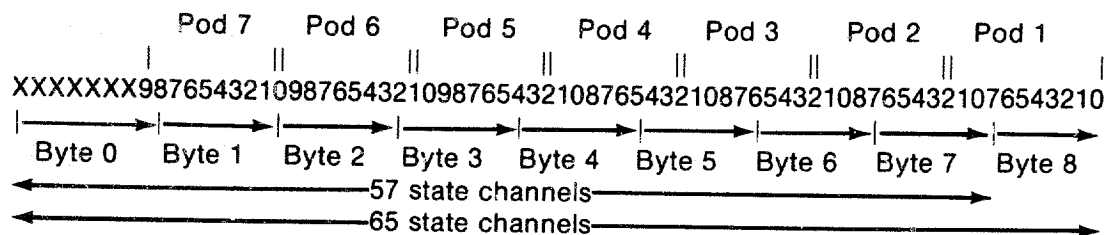

There are nine bytes per state for 57 state channel data, and eight bytes per state for 65 state channel data.

HP 1630G Learn String Format (for State Trace Data)

SYNTAX: TS;

Starting Byte Position In String	Number Of Bytes	Contents
1	2	(A) AS (Accept State Command)
3	2	(I) Binary byte count (refer to Note)
		CRC STARTS ACCUMULATING WITH NEXT BYTE
5	7	(I,B) Date/Time information
12	1	(S) This is time positional data
13	1	(S) Count all states, not time between states
14	1	(S) Counter values already converted to floating point
15	4	(R) Time positional measurement period in seconds
19	1	(S) Overview was program activity, not all states
20	1	(S) Type of Data (0 = State Trace Data)
21	1	(I) Number of state channels
22	2	(I) Number of valid states acquired
24	2	(I) Index of the tracepoint state
27	N	(I) Data Acquired $N = (\text{Number of Valid States}) * M$ Where: $M = 0$ if no state channels. $M = 11$ if 57 state channels. $M = 12$ if 65 state channels.
N + 28	2	CRC STOPPED ACCUMULATING WITH PREVIOUS BYTE (I) CRC

Note

The binary value of these bytes is the number of bytes to follow including the CRC bytes. This value is transmitted as MSB first and LSB last. The maximum number of bytes that can be transmitted is 5689 for 57 channels and 6204 for 65 channels.

HP 1630G Learn String Format (for State Label Overview)

SYNTAX: TS;

<u>Starting Byte Position In String</u>	<u>Number Of Bytes</u>	<u>Contents</u>
1	2	(A) AS (Accept State Command)
3	2	(I) Binary byte count (refer to Note) CRC STARTS ACCUMULATING WITH NEXT BYTE
5	7	(i,B) Date/Time information
12	1	(S) This is time positional data
13	1	(S) Count all states not time between states
14	1	(S) Counter values already converted to floating point
15	4	(R) Time positional measurement period in seconds
19	1	(S) Overview was program activity, not all states
20	1	(I) Type of Data (1 = State Label Overview)
21	8	Internal
29	184	(I) Data acquired from 8 state label ranges-fewer bytes if less than 8 ranges
		Each state label range contains:
	2	Internal
	4	(R) Number of samples in this range
	6	(W) End address of this range
	6	(W) Start address of this range
	5	(A) The five character name of this range
261	5	(A) State assignment label (ADDRS, STAT, etc.)
266	6	Internal
275	4	(R) Total number of samples taken (excluding "Other" range)
279	4	(R) Number of samples in "Other" range
283	2	CRC STOPPED ACCUMULATING WITH PREVIOUS BYTE (I) CRC

NOTE

The binary value of these bytes is the number of bytes to follow including the CRC bytes. This value is transmitted as MSB first and LSB last. The maximum byte count is 280.

HP 1630G Learn String Format (for Time Interval Overview)

SYNTAX: TS;

<u>Starting Byte Position In String</u>	<u>Number Of Bytes</u>	<u>Contents</u>
1	2	(A) AS (Accept State Command)
3	2	(I) Binary byte count (refer to Note) CRC STARTS ACCUMULATING WITH NEXT BYTE
5	7	(I,B) Date/Time information
12	1	(S) This is time positional data
13	1	(S) Count all states, not time between states
14	1	(S) Counter values already converted to floating point
15	4	(R) Time positional measurement period in seconds
19	1	(S) Overview was program activity, not all states
20	1	(I) Type of data (2 = State Time Interval)
21	4	(R) Total number of samples
25	4	(R) Total accumulated time
29	4	(R) Minimum interval found
33	4	(R) Maximum interval found
37	4	(R) Average time of interval
41	4	(R) Time of last interval acquired
45	8	Internal
53	112	(I) Data acquired from 8 time interval ranges- fewer bytes if less than 8 ranges
		Each time interval range contains:
	2	Internal
	4	(R) Number of samples in this range
	4	(R) End time of this range
	4	(R) Start time of this range
165	2	(I) CRC

NOTE

The binary value of these bytes is the number of bytes to follow including the CRC check bytes. This value is transmitted as MSB first and LSB last. The maximum byte count is 162.

HP 1630G Learn String Format (for Time Positional Overview)

SYNTAX: TS;

<u>Starting Byte Position In String</u>	<u>Number Of Bytes</u>	<u>Contents</u>
1	2	(A) AS (Accept State Command)
3	2	(I) Binary byte count (refer to Note) CRC STARTS ACCUMULATING WITH NEXT BYTE
5	7	(I,B) Date/time information
12	1	(S) This is time positional data
13	1	(S) Count all states, not time between states
14	1	(S) Counter values already converted to floating point
15	4	(R) Time positional measurement period in seconds
19	1	(S) Overview was program activity, not all states
20	1	(I) Type of data (3 = Time Positional Overview)
21	1	(I) Number of state channels
22	2	(I) Number of valid states acquired
24	2	(I) Index of tracepoint state
26	1	(S) Count all states, not time between states
27	N	Data acquired
N + 27	2	CRC STOPPED ACCUMULATING WITH PREVIOUS BYTE (I) CRC

NOTE

The binary value of these bytes is the number of bytes to follow including the CRC bytes. This value is transmitted as MSB first and LSB last. The maximum byte count is 12300.

HP 1630G Learn String Format (for Linkage Overview)

Syntax: TS;

<u>Starting Byte Position In String</u>	<u>Number Of Bytes</u>	<u>Contents</u>
1	2	(A) AS (Accept State Command)
3	2	(I) Binary byte count (refer to Note)
5	7	CRC STARTS ACCUMULATING WITH NEXT BYTE
12	1	(I/B) Date/time information
13	1	(S) This is time positional data
14	1	(S) Count all states, not time between states
15	4	(S) Counter values already converted to floating point
19	1	(R) Time positional measurement period in seconds
20	1	(S) Overview was program activity, not all states
21	4	(I) Type of data (4 = State Linkage Overview)
25	4	(B) Total number of samples taken
29	4	(R) Total number of linkage events found
37	8	Internal
	N	Data acquired N = (Number of valid states) * M Where: M = Number of linkage events
	2	Each linkage event contains: Internal
	4	(R) Number of samples in this linkage event
	5	(A) the name of this linkage event
N + 37	2	CRC STOPPED ACCUMULATING WITH PREVIOUS BYTE (I) CRC

NOTE

The binary value of these bytes is the number of bytes to follow including the CRC check bytes. This value is transmitted as MSB first and LSB last. The maximum byte count is 122.

TT - Transmit Timing Acquisition Learn String

The transmit timing acquisition learn string command causes the HP 1630G analyzer to transmit a string containing its timing measurement data plus two CRC bytes. Glitch information will also be transmitted if the analyzer is in the glitch mode of operation.

The actual timing data is transmitted as in the following manner:

1 byte per record for 8 channels

```
| Pod 0 |
76543210
| Byte 0 |
| 8 chan |
```

When the contents of the acquisition is formatted as real data (R), the number refers to number of marks or number of sample period intervals.

HP 1630G Learn String Format (for Timing Trace Learn)

SYNTAX: TT;

<u>Starting Byte Position In String</u>	<u>Number Of Bytes</u>	<u>Contents</u>
1	2	(A) AT (Accept Timing Command)
3	2	(I) Binary byte count (refer to Note)
		CRC STARTS ACCUMULATING WITH NEXT BYTE
5	1	(I) Number of timing channels
6	2	(I) Number of valid timing states
8	2	(I) Index of the tracepoint state
10	1	(S) Glitch mode on
11	2	(T) Sample period
13	7	(I,B) Date/Time information
20	2	(I) Number of units to start trace after trigger
22	1	(I) Units for byte 20 (0=ns, 1=us, 2=ms, 3=s)
23	4	(R) Valid pattern duration
27	1	(S) State was master
28	N	(I) Data File
		Where: N = Number of records
		CRC STOPPED ACCUMULATING WITH PREVIOUS BYTE
N + 28	2	(I) CRC

Note

The binary value of these bytes is the number of bytes to follow including the CRC bytes. The maximum binary number, if the memory is full, is 10491 for 8 channels. With partial memories, the binary value of these bytes will include the last word in memory plus two CRC bytes.

TE - Transmit Everything Learn String

The transmit everything learn string command instructs the analyzer to transmit the following data in the listed sequence: (1) configuration learn string, (2) state data acquisition learn string, and (3) timing data acquisition learn string. Refer to the TC, TS, and TT command descriptions for learn string formats. The maximum number of bytes will be the sum of the bytes of the individual commands. The maximum number of bytes (5476) will occur in the combined State/Timing Mode.

DATA TRANSFER TERMINATION

Binary transfers of data are terminated by setting EOI true with the last byte transferred. Non-binary transfers are terminated by sending CR LF with EOI true.

Appendix A

Display Messages

This appendix lists and defines each of the status, error, and prompt messages that the analyzer presents on screen.

All names must be unique - This message is displayed when a name has been created that is identical to one of the other names already in use on that menu.

At least 1 clock edge required - This message is displayed when the CLOCK field in the state FORMAT specification is set up so that no clock line is active.

Continuous trace in process - This message is displayed when the analyzer has a continuous trace in process, such as during the execution of an overview measurement.

Data acquired Month, Day, Year, Time - This message indicates when the current trace data was acquired. The initial setting is filled in from the clock set in the system peripherals menu. If the clock was not set when the trace was taken, this message will not be displayed at all.

Delaying - This message pertains to a trace in progress.

Delay too big for sample period - This message is displayed when a trigger delay is selected, in the timing TRACE specification, that is too long for the analyzer to measure using its present sample period selection.

DELETE to remove field - This message is displayed on menus which have all available fields assigned, such as when the state [Assignment] menu of the FORMAT specification has 8 labels assigned. This message prompts to delete fields from a full menu.

DELETE(write) / DEFAULT required - This message is displayed when an entry has been made in the highlighted file description line. Either press the DELETE key to write the instrument configuration to that tape file, or press the DEFAULT key to return the edited line to its previous unedited condition.

Each label must have a name - This message is displayed when INSERT is pressed to create a new label, before making any entry into the field for naming that new label.

ERROR cassette contains non HP1630 data - This message is displayed when the analyzer reads directory information that is not as written by the analyzer. The tape can be erased and reformatted if it is still to be used with the analyzer.

ERROR configuration too complex - The current state of the analyzer is too complex to be stored in internal storage. Simplify the analyzer configuration before retrying the operation. The power-up configuration is the simplest of all.

ERROR CRC does not match - This message is displayed when the Cyclic Redundancy Check (CRC) value read in during a learn string or down-loaded program did not match the CRC value calculated by the analyzer when it received the data. Could also mean an attempt was made to load an inverse assembler from internal storage that was corrupt.

ERROR directory full - the directory on the currently inserted disc has no more room for entries. Delete unwanted files before attempting to store to this disc.

ERROR disc changed - The disc has been changed since the last INSERT to check for disc was performed.

ERROR disc failure - The disc drive logic has failed. Indicates possible problems with the disc drive.

ERROR disc is not LIF disc - The disc inserted in the addressed unit is not in an appropriate format. Discs used by the 1630G must be in LIF (Logical Interchange Format).

ERROR disc is write protected - A write, delete, or format operation was attempted on a write protected disc.

ERROR disc operation aborted - A disc operation was stopped prematurely.

ERROR disc unformatted - The currently inserted disc is unformatted. It must be a LIF (Logical Interchange Format) disc.

ERROR DON'T CARE not allowed - This message is displayed when the DON'T CARE key is pressed and the cursor is in a field where "don't care" entries can not be accepted.

ERROR duplicate HP-IB address - The logic analyzer, printer, and disc must all be assigned unique HP-IB addresses.

ERROR file not found - The desired file was not found on the addressed disc unit.

ERROR format failed - Attempt to format a bad disc medium.

ERROR illegal file name - A disc file name must start with a letter, followed by an optional sequence of letters and/or numerals. No spaces, hyphens, or underscores are allowed.

ERROR in controller command - This message is displayed when the analyzer received a command from the controller (HP-IB or HP-IL) and did not recognize the command. A second line shows??? with the first character of the unrecognized command in inverse video.

ERROR in HP-IB transfer - The HP-IB interface is not operating properly.

ERROR internal: bad file length - Indicates internal problems with the analyzer. Record events leading up to this message and contact Hewlett- Packard.

ERROR internal: bad file type - Indicates internal problems with the analyzer. Record events leading up to this message and contact Hewlett- Packard.

ERROR internal: bad request - Indicates internal problems with the analyzer. Record events leading up to this message and contact Hewlett- Packard.

ERROR internal: disc error - Indicates internal problems with the analyzer. Record events leading up to this message and contact Hewlett- Packard.

ERROR internal: undefined error - Indicates internal problems with the analyzer. Record events leading up to this message and contact Hewlett- Packard.

ERROR invalid in this trace mode - This message is displayed when a display is requested that is not available in the selected trace mode, such as a trace list when the analyzer is performing an overview measurement.

ERROR inverse assembler too big - An attempt was made to store an inverse assembler in internal storage but it was larger than the available space.

ERROR LIF directory too big - A disc with too many LIF directory entries is in the addressed drive. Use a different disc.

ERROR maximum INSERT's used - This message is displayed when the INSERT key is used to insert an additional field, such as another label in the [Assignment] menu of the FORMAT specification, and the menu already has as many entries of that type as it can accept.

ERROR no cassette in drive - This message is displayed when the door on the cassette is open or no tape is currently in the drive when a read or write operation is attempted.

ERROR no disc drive present - There is no disc drive at the present address.

ERROR no disc media present - There is no disc inserted in the addressed unit.

ERROR no room on disc - The current disc is too full to complete the selected operation.

ERROR not 1630G compatible - The inverse assembler just loaded is not compatible with the 1630G logic analyzer.

ERROR numeric entry required - This message is displayed when a non-numeric key is pressed, such as NEXT[], and the cursor is in a field that accepts only numeric entries.

ERROR only bits 0-3 edge trigger - This message is displayed when trying to assign edge triggering to one of the timing bits that does not have edge-trigger capability.

ERROR operation time out - The current HP-IB disc operation was not completed. It was aborted because of a lack of response from the disc.

ERROR reload disc first - The cursor must be positioned on the top line of the Storage Operations menu, then the INSERT key pressed, before the desired operation can be completed.

ERROR requires correction first - This message is displayed when a partial specification has been entered, and before completing it, another analyzer menu is selected, such as when entering the name of a label in the FORMAT specification, and then trying to change to the TRACE specification before assigning a bit for that label.

ERROR requires file description - This message is displayed when an attempt has been made to write a tape file without creating a file description.

ERROR RESUME not allowed - This message is displayed when the RESUME key has been pressed for an operation that the analyzer has completed and cannot resume.

ERROR tape operation aborted - This message is displayed when the STOP key has been pressed during a tape read or write operation, or when a data error has been detected by the analyzer.

ERROR unexpected EOI - The disc drive logic has failed. Indicates possible problems with the disc drive.

ERROR use alphanumeric keys - This message is displayed after pressing the NEXT[] or PREV[] keys while the cursor is in a field which accepts only alphanumeric entries, such as a module name field in the [User Base] menu of the FORMAT specification.

ERROR use CHS key - This message is displayed when the cursor is on a mathematical sign, and something other than the CHS (change sign) key is pressed.

ERROR use hex keys - This message is displayed when pressing a non-hex key when the cursor is in a field that accepts only hexadecimal entries.

ERROR use NEXT[] PREV[] keys - This message is displayed when pressing a keyboard letter or number key a field where selections must be made with the NEXT[] or PREV[] keys.

Display Messages

ERROR use 0 or 1 - This message is displayed when trying to enter a non-binary character in a specification that is set to accept only binary entries.

ERROR use 0, 1, or DON'T CARE - This message is displayed when trying to enter a non-binary character in a specification field that is set up to accept only binary or "don't care" entries.

ERROR use 0 thru 3 - This message is displayed when trying to enter too large a value into a field made up of only two bits, and set to accept a number base other than binary.

ERROR use 0 thru 3 or DON'T CARE - This message is displayed when trying to enter too large a value into a field made up of only two bits, and set to accept either a DON'T CARE, or a number with a non-binary base.

ERROR use 0 thru 7 - This message is displayed when pressing an "8" or "9" key for an entry in a field that accepts only numbers in the octal number base or is made up of only 3 bits.

ERROR use 0 thru 7 or DON'T CARE - This message is displayed when trying to enter a non-octal character in a specification field that is set up to accept only octal or "don't care" entries, or is made up of only 3 bits.

ERROR value is too large - This message is displayed when pressing a numeric key in a numeric field, but the number is too large for the cursor position in the numeric field.

ERROR write protected file - This message is displayed when the highlighted bar is on a file that is write protection enabled and a write operation is attempted.

ERROR 1630A/D learn string - The 1630G has been sent a learn string that was generated for a 1630A or 1630D logic analyzer. Learn strings from other analyzers are not compatible with the 1630G.

INSERT to add compare item - This message is displayed in the state and compare list display. It indicates that a duplicate of the line shown in inverse video can be added to the compare list by pressing the INSERT key.

INSERT to add new label - This message is displayed when the cursor is in the label field of the format [Assignment] menu. It describes what must be done to create a new label in this menu.

INSERT to add new module - This message is displayed when creating code modules on the [Relocation] menu of the FORMAT specification. It describes what must be done to create an additional code module in the map.

INSERT to add new range - This message is displayed when the cursor is in the range field of a menu, and the analyzer has space available in that field for creating additional ranges.

INSERT to add or'd pattern - This message is displayed when the cursor is in the proper position to allow entry of an additional term to be OR'd with the present term in the specification. It describes what must be done to create this additional term.

INSERT to add sequence term - This message is displayed when the cursor is in the proper position to allow entry of a sequence term. It describes what must be done to create a new sequence term in this menu.

INSERT to add traces - This message is displayed in the waveform display when the cursor is in the proper area to add more waveform channels to the display. The message indicates how to add the additional channels.

INSERT to autoscale - This message is displayed in the chart menus. Press INSERT to set the max and min scale values to the maximum and minimum data values currently displayed.

INSERT to correlate x cursor - This message is displayed in the waveform menus of an interactive state/timing measurement if the current trace was state triggers a don't care timing trace. Press INSERT to align (in time) the displayed x cursor (Example: state) with the non-displayed (Example: timing) x cursor.

INSERT to check for disc - This message is displayed when the cursor is in the top row of the Storage Operations menu. Pressing INSERT will cause the analyzer to see if a disc is present at the assigned HP-IB address and unit.

INSERT to confirm - Before the current operation can continue, INSERT must be pressed to confirm that the selected operation is desired.

INSERT to inverse assemble - This message is displayed in the state list menu when certain inverse assemblers are active. The current inverse assembler cannot accurately determine where the first state of an instruction fetch is. Position the display so that the state aligned with the inverse video line number is the first state of an instruction fetch. Press INSERT to start the inverse assembly from the indicated state.

INSERT to overwrite - A request has been made to overwrite a disc file. Before the old file is destroyed, INSERT must be pressed to overwrite it.

INSERT to start operation - This message is displayed when the cursor is in the bottom row of the Storage Operations menu. Pressing INSERT will cause the analyzer to begin the currently selected operation.

INSERT to store compare image - This message is displayed in the state full compare list menu when viewing the trace data. Press INSERT to store the current trace data as the compare image.

Internal message error - Indicates internal problems with the analyzer. Record events leading up to this message and contact Hewlett-Packard.

Invalid clock setting - This message is displayed when the analyzer clock in the SYSTEM [Peripherals] menu has not been set to a correct date. The clock date must be later than December, 1981.

NOTE: Compare list is empty - This message is displayed when the state Compare traced mode is selected and the list in the compare memory has no entries.

NOTE: Cursor correlation is not available - This message will appear during interactive state/timing measurements if conditions other than State Master and Timing Don't Care are set up. For example if state is master and timing is set to trigger on a pattern or glitch.

NOTE: No stored compared image - This message is displayed when the state Full Compare mode is selected.

NOTE: Trace data has less states than compare image. This message is displayed in the trace compare modes when the trigger is centered on, or ends the trace.

NOTE: Trace data has more states than compare image. This message is displayed in the trace compare modes when the trigger is centered on, or ends the trace.

Max 43 *'s per label - State format labels can have a maximum of 43 bits allocated.

One "*" required for each label - This message is displayed when a name for a new label has been created before assigning the first bit to be identified by that label.

Operation aborted - The current operation has been aborted. Example: occurs when STOP is pressed during a save configuration to internal storage.

Power-up complete - This message is displayed after the analyzer has successfully completed the power-up test routine.

Reading directory - The analyzer is reading the directory on the external mass storage device.

ROLL to change configuration - This message is displayed when in the SYSTEM [Configuration] menu. It prompts use of the ROLL keys to change the distribution of input bits between the state and timing measurement channels.

- ROLL to edit file description** - This message is displayed in the [Tape Operations] menu. It indicates that the ROLL keys will move the highlighted bar to the file description to be edited.
- Single trace in process** - This message is displayed while the instrument is making a single trace or is finishing up a trace after the STOP key was pressed during a continuous trace.
- Timing trace in process** - This message pertains to a trace in progress.
- Timing: XXXX secs to completion** - This message pertains to a trace in progress.
- Trace aborted** - This message is displayed after pressing the STOP key during a single trace execution, before that trace has been completed.
- Trace complete** - This message is displayed after the analyzer completes a single trace.
- WAIT checking directory** - This is a disc operation.
- WAIT creating directory** - This is a disc operation.
- WAIT disc operation in process** - The analyzer is currently accessing the external mass storage.
- WAIT formatting disc** - This disc operation can take up to 5 minutes.
- Waiting for sequence term** - This message pertains to a trace in progress.
- Waiting for start term** - This message pertains to a trace in progress.
- Waiting for state term** - This message pertains to a trace in progress.
- Waiting for stop term** - This message pertains to a trace in progress.
- Waiting for timing trigger** - This message pertains to a trace in progress.
- WAIT loading configuration** - This disc operation takes about 15 seconds.
- WAIT loading executable** - This disc operation takes about 15 seconds.
- WAIT loading internal storage** - This message is displayed while data is being transferred into the logic analyzers internal storage. Configurations take about 30 seconds. Inverse assemblers can take up to 3 minutes.
- WAIT loading inverse assembler** - This disc operation takes about 10 seconds.
- WAIT loading state data** - This disc operation takes about 25 seconds.
- WAIT loading timing data** - This disc operation takes about 5 seconds.
- WAIT PRINT in progress** - This message is displayed while the analyzer is sending data to a printer after the PRINT key has been pressed.
- WAIT reading cassette file** - This message is displayed after the INSERT key is pressed in the [Tape Operations] menu. The analyzer configuration plus data is read from the tape file that is highlighted by the inverse-video bar.
- WAIT reading directory** - This is a disc operation.

- WAIT saving configuration** - This message is displayed while a configuration is being transferred into internal storage. The operation takes about 30 seconds.
- WAIT storing configuration** - This disc operation takes about 15 seconds.
- WAIT storing state data** - This disc operation takes about 25 seconds.
- WAIT storing timing data** - This disc operation takes about 5 seconds.
- WAIT writing cassette file** - This message is displayed after the DELETE key is pressed in the [Tape Operations] menu. The analyzer configuration plus data is written to the tape file that is highlighted by the inverse-video bar.
- WARNING awaiting HP-IB transfer** - This message is displayed when the analyzer has been commanded to send data but the HP-IB controller is not accepting transmissions from the analyzer. The message will disappear when data transfer begins.
- WARNING awaiting HP-IL transfer** - This message is displayed when the analyzer has been commanded to send data but the HP-IL controller is not accepting transmissions from the analyzer. The message will disappear when data transfer begins.
- WARNING command ignored** - This message is displayed when attempting to execute a command that is invalid for the field that is identified by the position of the cursor, such as trying to INSERT a label in the [Assignment] FORMAT specification when the cursor is in the [Assignment] field.
- WARNING contains non-HP1630C data** - The analyzer has been sent a learn string that was generated on a 1630 family logic analyzer but not on a 1630G logic analyzer.
- WARNING cursor outside data** - An attempt to correlate the x cursor was made. The non-displayed x cursor is, with respect to time, outside the currently viewed data.
- WARNING new tape inserted** - The analyzer rereads the tape directory each time it enters the [Tape Operations] menu. This message is displayed when the directory read does not match the current memory of the [Tape Operations] menu.
- WARNING [NEXT/PREV] erases tape** - This message appears when the cursor is moved into the Erase & Format Cassette field. If the NEXT[] or PREV[] keys are pressed the analyzer will automatically erase and reformat the entire tape.
- WARNING press STOP key first** - This message appears after trying to change a trace parameter during a measurement. The analyzer cannot change trace parameters while a measurement is in process.
- WARNING printer down** - This message is displayed when the analyzer tries to send data to print a copy of the display on an external printer, and the data transfer is not taking place or has been suspended for approximately one second.
- WARNING slow clock** - This message is displayed when the repetition rate of the incoming state clock is slower than the minimum rate (< 400 Hz). It usually means that the analyzer is not receiving any clock activity on the line(s) selected to clock data.
- WARNING value not allowed** - This message is displayed when trying to enter too large a value into a decimal field.
- XXXX Intervals to completion** - This message pertains to a trace in progress. The Xs represent a decimal number that is continuously updated to reflect the current trace status.
- XXXX States to completion** - This message pertains to a trace in progress. The Xs represent a decimal number that is continuously updated to reflect the current trace status.

Appendix B. An HP-IB Overview

Introduction	B-1
HP-IB System Terms	B-1
Interface Bus Concepts	B-1
Message Concepts	B-2
The HP Interface Bus	B-3
HP-IB Lines And Operations	B-3
Interface Functions	B-5
Bus Messages	B-6
HP 1630 HP-IB Implementation	B-6

Appendix B

An HP-IB Overview

INTRODUCTION

The HP Interface Bus (HP-IB) provides an interconnecting channel for data transfer between devices on the HP-IB.

The following list defines the terms and concepts used to describe HP-IB (bus) system operations.

HP-IB SYSTEM TERMS

1. **Addressing** — The characters sent by a controlling device specifying which device sends information on the bus and which device(s) receives the information.
2. **Byte** — A unit of information consisting of 8 binary digits (bits).
3. **Device** — An unit that is compatible with the ANSI/IEEE 488-1978 Standard
4. **Device Dependent** — A response to information sent on the HP-IB that is characteristic of an individual device's design, and may vary from device to device.
5. **Operator** — The person that operates either the system or any device in the system.
6. **Polling** — The process typically used by a controller to locate a device that needs to interact with the controller. There are two types of polling:
 - **Serial Poll** — This method obtains one byte of operational information about an individual device in the system. The process must be repeated for each device from which information is desired.
 - **Parallel Poll** — This method obtains information about a group of devices simultaneously.

INTERFACE BUS CONCEPTS

Devices which communicate along the interface bus can be classified into three basic categories.

1. **Talkers** — Devices which send information on the bus when they have been addressed.
2. **Listeners** — Devices which receive information sent on the bus when they have been addressed.
3. **Controllers** — Devices that can specify the talker and listeners for an information transfer. Controllers can be categorized as one of two types:
 - **Active Controller** — The current controlling device on the bus. Only one device can be the active controller at any time.
 - **System Controller** — The only controller that can take priority control of the bus if it is not the current active controller. Although each bus system can have only one system controller, the system can have any number of devices capable of being the active controller.

A typical HP-IB system is shown below.

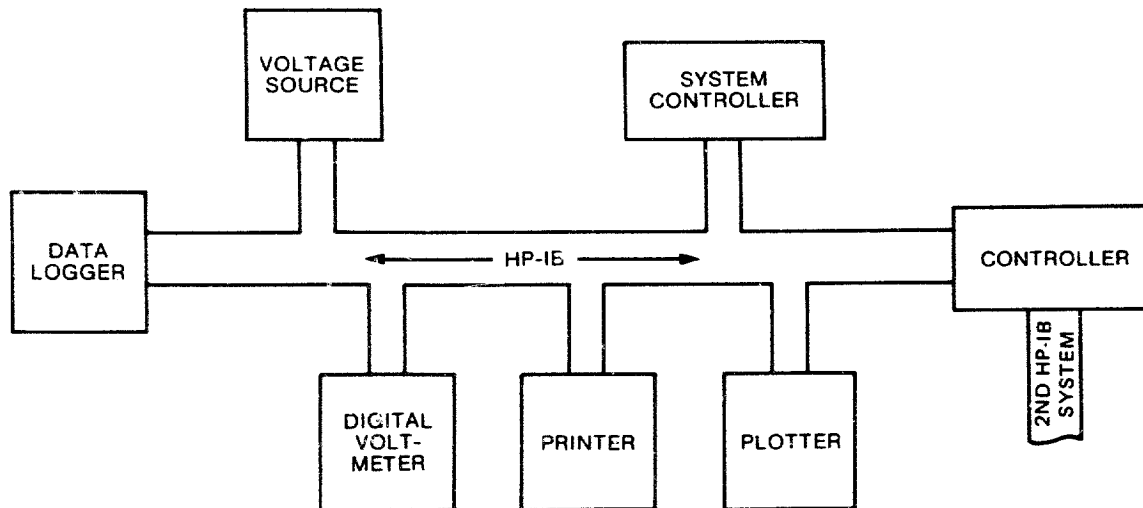

9872-A-172-1

MESSAGE CONCEPTS

Devices which communicate along the interface bus are transferring quantities of information. The transfer of information can be from one device to another device, or from one device to more than one device. These quantities of information can easily be thought of as "messages".

In turn, the messages can be classified into twelve types. The list below gives the twelve message types for the HP-IB.

1. **The Data Message** — This is the actual information which is sent from one talker to one or more listeners along the interface bus.
2. **The Trigger Message** — This message causes the listening device(s) to perform a device-dependent action when addressed.
3. **The Clear Message** — This message causes either the listening device(s) or all of the devices on the bus to return to their predefined device-dependent states.
4. **The Remote Message** — This message causes listening devices to switch from local front-panel to remote program control when addressed to listen.
5. **The Local Message** — This message clears the Remote Message from the listening device(s) and returns the device(s) to local front-panel control.
6. **The Local Lockout Message** — This message prevents a device operator from manually inhibiting remote program control.
7. **The Clear Lockout/Local Message** — This message causes all devices on the bus to be removed from Local Lockout and revert to Local. This message also clears the Remote Message for all devices on the bus.
8. **The Require Service Message** — A device can send this message at any time to signify that the device needs some type of interaction with the controller. This message is cleared by sending the device's Status Byte Message if the device no longer requires service.
9. **The Status Byte Message** — A byte that represents the status of a single device on the bus. Bit 6 indicates whether the device sent a Require Service Message, and the remaining bits indicate operational conditions defined by the device. This byte is sent from a talking device in response to a serial poll operation performed by a controller.

- 10. **The Status Bit Message** — A byte that represents the operational conditions of a group of devices on the bus. Each device responds on a particular bit of the byte thus identifying a device-dependent condition. This bit is typically sent by devices in response to a parallel poll operation.

The Status Bit Message can also be used by a controller to specify the particular bit and logic level that a device will respond with when a parallel poll operation is performed. Thus more than one device can respond on the same bit.

- 11. **The Pass Control Message** — This transfers the bus management responsibilities from the active controller to another controller.

- 12. **The Abort Message** — The system controller sends this message to unconditionally assume control of the bus from the active controller. This message terminates all bus communications (but does not implement a Clear Message).

These messages represent the full implementation of all HP-IB system capabilities. Each device in a system may be designed to use only the messages that are applicable to its purpose in the system. It is important for you to be aware of the HP-IB functions implemented on each device in your HP-IB system to ensure the operational compatibility of the system.

THE HP INTERFACE BUS

HP-IB Lines And Operations

The HP Interface Bus transfers data and commands between the components of an instrumentation system on 16 signal lines. The interface functions for each system component are performed within the component so only passive cabling is needed to connect the systems. The cables connect all instruments, controllers, and other components of the system in parallel to the signal lines.

The eight Data I/O lines (DI01 through DI08) are reserved for the transfer of data and other messages in a byte-serial, bit-parallel manner. Data and message transfer is asynchronous, coordinated by the three handshake lines: Data Valid (DAV), Not Ready For Data (NRFD), and Not Data Accepted (NDAC). The other five lines are for management of bus activity. See the figure on the right.

Devices connected to the bus may be talkers, listeners, or controllers. The controller dictates the role of each of the other devices by setting the ATN (attention) line true and sending talk or listen addresses on the data lines. Addresses are set into each device at the time of system configuration either by switches built into the device or by jumpers on a PC board. While the ATN line is true, all devices must listen to the data lines. When the ATN line is false, only devices that have been addressed will actively send or receive data. All others ignore the data lines.

Several listeners can be active simultaneously but only one talker can be active at a time. Whenever a talk address is put on the data lines (while ATN is true), all other talkers will be automatically unaddressed.

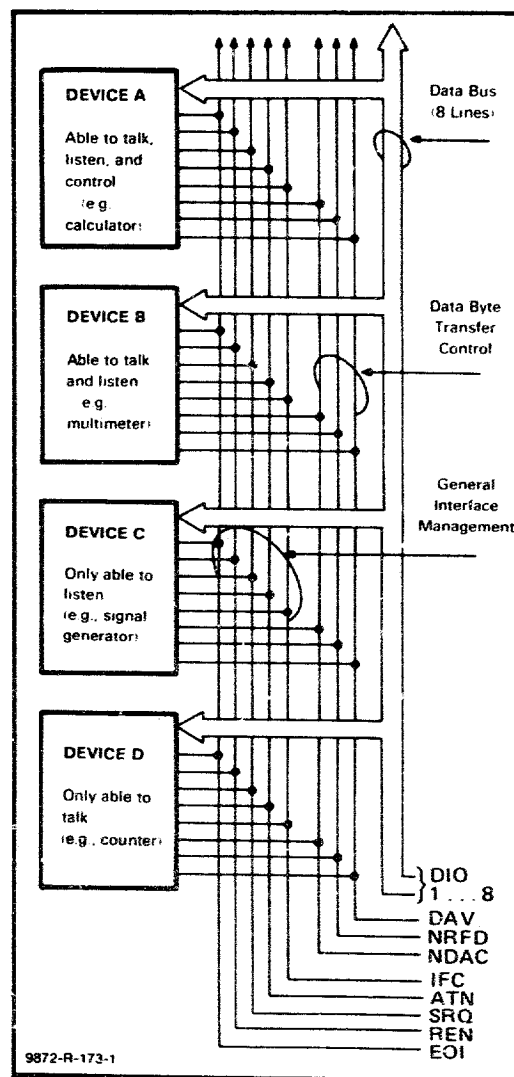

HP-IB Signal Lines

Information is transmitted on the data lines under sequential control of the three handshake lines (DAV, NRFD, and NDAC). No step in the sequence can be initiated until the previous step is completed. Information transfer can proceed as fast as devices can respond, but no faster than allowed by the slowest device presently addressed as active. This permits several devices to receive the same message byte concurrently.

The ATN line is one of the five bus management lines. When ATN is true, addresses and universal commands are transmitted on only seven of the data lines using the ASCII code. When ATN is false, any code of 8 bits or less understood by both talker and listener(s) may be used.

The IFC (interface clear) line places the interface system in a known quiescent state.

The REN (remote enable) line is used with the Remote, Local, and Clear Lockout/Set Local Messages to select either local or remote control of each device.

Any active device can set the SRQ (service request) line true via the Require Service Message. This indicates to the controller that some device on the bus wants attention, such as a counter that has just completed a time-interval measurement and wants to transmit the reading to a printer.

The EOI (end or identify) line is used by a device to indicate the end of a multiple-byte transfer sequence. When a controller sets both the ATN and EOI lines true, each device capable of a parallel poll indicates its current status on the DIO line assigned to it.

In the interest of cost-effectiveness, it is not necessary for every device to be capable of responding to all the lines. Each can be designed to respond only to those lines that are pertinent to its function on the bus.

The operation of the interface is generally controlled by one device equipped to act as controller. The interface transmits a group of commands to direct the other instruments on the bus in carrying out their functions of talking and listening.

The controller has two ways of sending interface messages. Multi-line messages, which cannot exist concurrently with other multi-line messages, are sent over the eight data lines and the three handshake lines. Uni-line messages are transferred over the five individual lines of the management bus.

The commands serve several different purposes:

- Addresses, or talk and listen commands select the instruments that will transmit and accept data. They are all multi-line messages.
- Universal commands cause every instrument equipped to do so to perform a specific interface operation. They include multi-line messages and three uni-line commands: interface clear (IFC), remote enable (REN), and attention (ATN).
- Addressed commands (also referred to as primary commands) are similar to universal commands, except that they affect only those devices that are addressed and are all multi-line commands. An instrument responds to an addressed command, however, only after an address has already told it to be talker or listener.
- Secondary commands are multi-line messages that are always used in series with an address, universal command, or addressed command to form a longer version of each. Thus they extend the code space when necessary.

To address an instrument, the controller uses seven of the eight data-bus lines. This allows instruments using the ASCII 7-bit code to act as controllers. As shown in the table, five bits are available for addresses, and a total of 31 allowable addresses are available in one byte. If all secondary commands are used to extend this into a two-byte addressing capability, 961 addresses become available (31 allowable addresses in the second byte for each of the 31 allowable in the first byte).

Command and Address Codes

Code Form							Meaning	
X	0	1	A5	A4	A3	A2	A1	Universal Commands Listen Addresses
X	0	1	A5	A4	A3	A2	A1	
except								
X	0	1	1	1	1	1	1	Unlisten Command
X	1	0	A5	A4	A3	A2	A1	Talk Address
except								
X	1	0	1	1	1	1	1	Untalk Command
X	1	1	A5	A4	A3	A2	A1	Secondary Commands
except								
X	1	1	1	1	1	1	1	Ignored

Code used when attention (ATN) is true (low).
X = don't care

INTERFACE FUNCTIONS

Interface functions provide the physical capability to communicate via HP-IB. These functions are defined in the ANSI/IEEE 488-1978 Standard. This standard, which is the designer's guide to the bus, defines each interface function in terms of state diagrams that express all possible interactions.

Bus capability is grouped under 10 interface functions, for example: Talker, Listener, Controller, Remote/Local. The following table lists the functions, including two special cases of Controller.

HP-IB Interface Functions

Mnemonic	Interface Function Name
SH	Source Handshake
AH	Acceptor Handshake
T	Talker (or TE = Extended Talker)*
L	Listener (or LE = Extended Listener)*
SR	Service Request
RL	Remote Local
PP	Parallel Poll
DC	Device Clear
DT	Device Trigger
C	Any Controller
CN	A Specific Controller (for example: CA, CB . . .)
CS	The System Controller

*Extended Talkers and Listeners use a two-byte address. Otherwise, they are the same as Talker and Listener.

BUS MESSAGES

Since interface functions are the physical agency through which bus messages are implemented, each device must implement one or more functions to enable it to send or receive a given bus message.

The following table lists the functions required to implement each bus message. Each device's operating manual lists the functions implemented by that device. Some devices, such as the 98034A Interface, list the functions implemented directly on the device.

Functions Used By Each Bus Message

Bus Message	Functions Required sender function - receiver function(s) (support functions)
Data	T - L* (SH, AH)
Trigger	C - DT* (L, SH, AH)
Clear	C - DC* (L, SH, AH)
Remote	CS - RL* (SH, AH)
Local	C - RL* (L, SH, AH)
Local Lockout	C - RL* (SH, AH)
Clear Lockout/Set Local	CS - RL*
Require Service	SR* - C
Status Byte	T - L* (SH, AH)
Status Bit	PP* - C
Pass Control	CA - CB (T, SH, AH)
Abort	CS - T, L*C

*Since more than one device can receive (or send) this message simultaneously, each device must have the function indicated by an *.

HP 1630 HP-IB IMPLEMENTATION

Functions Implemented (ANSI/IEEE 488-1978)

HP-IB Implementation: when 1630 is non-controller

- a. Source Handshake (SH1)
- b. Acceptor Handshake (AH1)
- c. Talker (T6) Serial Poll
- d. Talker-Extended (TE0) No
- e. Listener (L4)
- f. Listener-Extended (LE0) No
- g. Service Request (SR1)
- h. Remote/Local (RL1) Yes
- i. Parallel Poll (PP1)
- j. Device Clear (DC1)
- k. Device Trigger (DT1)
- l. Controller (C0) No
- m. Drive Electronics (E2) Tri-state

Appendix C. Using A Printer

Introduction	C-1
Obtaining Hard Copy From A Printer	C-1
Using A Controller To Operate The Analyzer And Printer	C-2

Appendix C

Using A Printer

INTRODUCTION

The analyzer can be connected through an HP-IB interface cable to a graphics printer that understands the HP-IB command set, and the analyzer can control the printer to obtain hard copies of any of its displays, as well as hard copies of the entire content of its list memory. This appendix lists the steps required to connect a printer to the analyzer and obtain hard copy.

The speed with which you can obtain a copy of a display depends upon which printer you are using, the complexity of the display you want to copy, and whether you are using HP-text or HP-graphics (selected in [Peripherals] SYSTEM menu) to transfer information. Use the following information as a guide to estimating the printer speed of your system.

Max. Data Transfer rate: 4k bytes/sec approximately.

Example times for making copies on HP 2671G printer using [Text] language ([Text] is approximately twice as fast as [Graphics]):

Copy small menu: 7 seconds approximately.

Copy large menu: 20 seconds approximately.

Copy complete timing diagram: 30 seconds approximately.

Copy Max width list (8 labels): 85 words/min approximately. Full 1K list can be copied in approximately 12 minutes.

OBTAINING HARD COPY FROM A PRINTER

The following procedure is written to help you hook up a printer through an HP-IB interface cable, and obtain hard copies of displays.

1. Connect an HP-IB interface cable between the analyzer rear panel and the printer.
2. Set the address switches on the analyzer rear panel to the TALK ONLY position (address switches 7 and 8 to 00).
3. Set the printer to the "listen only" mode.
4. Turn on operating power at the printer.
5. Turn analyzer LINE power off and then on again. When the analyzer executes its power-up routine, it will read the position of the address switches. To check this, select the [Peripherals] menu in the SYSTEM menu set, and see that the display says, "System Controller: NONE/TALK ONLY".
6. Set up a display on the analyzer that you would like to copy and press the analyzer PRINT key. The analyzer will send the commands required to obtain a complete copy of the display. If you copied a list display, note that the line number which was in inverse-video is underlined in the print using HP-text and in inverse-video using HP-graphics.
7. You can obtain a copy of the trace memory beyond the portion shown on the display, if desired. To do this, place the list display on screen. Then use the ROLL keys to get the first line of the desired copy on screen (if you want to start your copy at the line +0100, roll the display to the point where line +0100 is the top line on screen).
8. Press the blue shift key and PRINT ALL key. The analyzer will activate the printer and start printing with the top line on screen. It will continue to send print information to the printer until the entire content of the trace memory has been printed. It will resend the heading information each time it starts a new page.

9. You can stop the print before the entire 1K memory has been printed, if desired. To do this, press the analyzer STOP key. When you press the STOP key, the analyzer will stop sending new information to the printer buffer. The information for the lines on screen will already be in the printer buffer. The print will continue until the last line of the present display is printed. Then it will halt.

USING A CONTROLLER TO OPERATE THE ANALYZER AND PRINTER

Reset the analyzer address switches to the HP-IB CONTROLLED or HP-IL CONTROLLED positions, as applicable, and cycle the analyzer LINE power. Check to see that the SYSTEM [Peripherals] menu shows that the analyzer is controlled and that it lists the desired address. Refer to appendix C for the complete list of device-dependent commands for controlling operation of the analyzer.

In the controlled mode, the PRINT key can still be used to obtain hard copy from a printer. If you press the PRINT key (or "PR" sent from controller), the analyzer must be addressed to talk and the printer addressed to listen before the print will occur.

Appendix D. Using The Disc Memory Accessory

Introduction	D-1
Connecting The 9121 D/S Flexible Disc Drive	D-1
The Storage Operations Menu	D-1
How To Read A Disc File	D-2
How To Create A New Disc File	D-3
How To Find A Disc File	D-3
How To Delete A Disc File	D-4
How To Load An Inverse Assembler From Disc To Internal Storage	D-4
How To Format A Disc	D-5

Appendix D

Using The Disc Memory Accessory

INTRODUCTION

This appendix describes how to use the HP 9121D/S Flexible Disc Drive as an accessory to store and load test setups and captured data.

The HP 9121S is a single 3-1/2 inch flexible disc drive and the 9121D is a dual 3-1/2 inch flexible disc drive. When using the 9121D, the logic analyzer can be addressed to only one of the disc units at a time.

CONNECTING THE 9121 D/S FLEXIBLE DISC DRIVE

To connect the 9121D/S Flexible Disc Drive, the following steps should be followed:

1. Connect power to the 9121D/S disc drive.
2. Connect an HP-IB cable from the logic analyzer HP-IB output to the 9121D/S HP-IB connector.
3. Set the HP-IB address switches on the rear panel of the 9121D/S to the desired operating address. More than one disc drive may be connected to the HP-IB, however, each must have a unique address assignment.
4. Install one or two 3-1/2 inch flexible discs into the 9121 by pressing the disc all the way into the disc drive unit.
5. Apply power to the Flexible Disc Drive. When power is applied to the disc drive it goes through an initialization sequence which causes the indicator lamps to momentarily light.

THE STORAGE OPERATIONS MENU

The [Storage Operations] menu is selected from the SYSTEM menu subset. When the 1630 is powered up, the cursor is flashing in the [Configuration] field. Press PREV[], NEXT[] keys until the cursor is in the [Storage Operation] field. Refer to figure D-1 for the following explanation.

The [Storage Operations] menu contains the following:

1. Bus Address field — defaults to the lowest available bus address (i.e., the printer is normally Bus Address 1, if the 1630 is at address 0, then the default Bus Address for the disc is 2; if the 1630 is any other address, then the default Bus Address for the disc is 0). Any Bus Address 0 through 7 may be manually entered.
2. Unit field — defaults to zero. A unit number between 0 and 7 may be entered. This is the unit number of the disc to be used. With the 9121D this number may only be 0 or 1.
3. Disc type — defaults to None and contains the model number of the disc drive after a disc is read. This is a response from the disc drive to a request of the 1630.
4. Bus Address — defaults to 0 and is the HP-IB address that the 1630 is using to address the disc. When the INSERT key is pressed this address will be the same as the Bus Address that is contained in the user entry field.
5. LIF volume — defaults to None. Data is entered when the disc is read. Contains an identifier code from the instrument that formatted the disc.

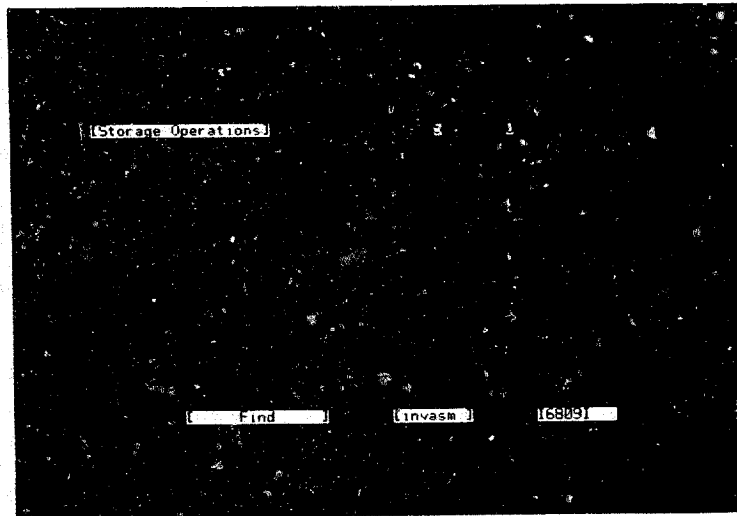

Figure D-1. The [Storage Operations] Menu

6. Disc Unit — defaults to zero and is the unit number of the disc drive the 1630 is using to address the disc.
7. File directory — contains the following information:

File Name — any name assigned by the originator of the file. The file name must begin with an alpha character, be a maximum of 9 characters and contain only alpha and numeric characters.

Type — indicates the type of file on the disc. See "How to Store a File" for more information.

Date/Time — is the date and time that was set on the 1630 when the file was recorded.

File Description — description as entered by the file originator of the file. This is not a required entry.

On prerecorded inverse assembler discs all inverse assembler files begin with the letter "I". This is followed by the processor name of the inverse assembler. The last character of the Name field contains an "I" or "P", indicating the inverse assembler is for use with the 10269A/B interface (I) or for General Purpose Probes (P).

The File Description field contains a description of the inverse assembler followed by one or more spaces, then a four digit date code. The date code is changed if the inverse assembler software is changed. The larger number will be the most recent software revision.

HOW TO READ A DISC FILE

1. When the logic analyzer is powered up, the [Configuration] menu will be displayed and the cursor is in the [Configuration] field. Press NEXT[], PREV[] keys until the [Storage Operations] menu is displayed. Move the cursor to the Bus Address field by pressing the CURSOR right key one time.
2. Enter the unit number of the disc drive to be used by pressing the CURSOR right key once and entering the unit number.

NOTE

Unit Number defaults to 0 at power up, therefore if unit 0 is to be the active disc drive no entry need be made.

3. Obtain the directory of the disc files by pressing the INSERT key. When INSERT is pressed, the disc unit selected is read and the disc directory is displayed on the logic analyzer screen. Response time may be up to 4 seconds.

4. Load the desired file from the disc into the logic analyzer memory by placing the file name to be loaded next to the directory pointer (greater than sign; >) by pressing the ROLL keys. Then move the cursor to the Operation field at the bottom of the menu and press NEXT[], PREV[] keys until [Load] is displayed, then press the INSERT key to actually load the file from the disc.

HOW TO CREATE A NEW DISC FILE

1. Place the cursor in the Operation field and press NEXT[], PREV[] keys until [Store] is displayed.
2. Press the CURSOR right key to place the cursor in the Type field and press NEXT[], PREV[] keys until the type of data you wish to store is displayed as follows:
 - a. [config] — stores all menu configurations, except Storage Operations on disc. The clock data on the peripherals menu is not stored.
 - b. [state] — stores all state data.
 - c. [timing] — stores all timing data.
 - d. [a!l] — stores all configuration, state and timing information.
3. Press the CURSOR right key once to place the cursor in the Name field. Enter a Name in the name field.

NOTE

The File Name must begin with an alphabetic character, be a maximum of 9 characters and contain only alpha and numeric characters.

4. Add a description of the file as required, then press the INSERT key to actually store the data. To place a space in the description use the DON'T CARE key. CLEAR will clear the entire description field.

While the data is being stored, the disc drive indicator lamps will be lit. After the disc operation the new file name will appear in the directory of the menu, aligned with the indicator ().

HOW TO FIND A DISC FILE

1. Enter the [Storage Operations] menu and load the file directory from the disc.
2. Place the cursor in the Operation field and select [Find].
3. Press the CURSOR right key once and select the proper type of file. The type file [prog] is a file that has been down loaded from another system, and the "prog" type label is displayed. The "unknown" Type file is written by another controller, therefore, the 1630 cannot identify the file type.
4. Move the cursor to the Name field and enter the name of the file that is to be found.

NOTE

If the file type or file name is not correct the file will not be found and the error message "ERROR file not found" will be displayed.

5. Press the INSERT key to actually find the file name in the directory.

NOTE

The file name is located in the directory, however, the file must be loaded to the 1630 memory in a separate operation. If the file is not found, the directory pointer will be left pointing to the file that is alphabetically following the file that could not be found.

HOW TO DELETE A DISC FILE

1. Enter the [Storage Operations] menu and display the disc directory.
2. Place the cursor in the Operation field and press NEXT[, PREV[] keys until [Delete] is displayed in this field.
3. Press the CURSOR right key once to place the cursor in the Type field and press NEXT[, PREV[] keys until the proper type of file is displayed.
4. Press the CURSOR right key once to place the cursor in the Name field and enter the name of the file to be deleted. Press the INSERT key once, the advisory "Insert to confirm" will be displayed, press the INSERT key again to actually start the delete operation.

NOTE

If type is set to [all] then [config], [state] and [timing] files with that file name will be deleted.

While the data is being deleted the disc indicator lamps will be lit. After the disc operation is complete, the name of the deleted file is gone and the directory pointer will indicate the file that was just preceding the deleted file.

HOW TO LOAD AN INVERSE ASSEMBLER FROM DISC TO INTERNAL STORAGE

1. Enter the [Storage Operations] menu and display the directory for the disc files.
2. Place the cursor in the Operation field and press PREV[, NEXT[] keys until [IA to internal] is displayed.
3. Press the cursor right key twice to place the cursor in the Name field, then enter the name of the inverse assembler to be loaded.

NOTE

The Type field can be entered by the cursor, however, it cannot be changed in this mode.

4. Press the INSERT key to load the inverse assembler from the disc to internal storage. The inverse assembler is also loaded into the analyzer RAM to make it active and sets the "Autoload inverse assembler from internal storage" to yes, so at the next power up the inverse is automatically loaded.

Several disc operations are required to transfer the entire inverse assembler to internal storage.

HOW TO FORMAT A DISC

When a disc is formatted any data on the disc is erased and the disc directory is set up to contain a maximum of 256 file name entries. The number of data files that can be stored on a disc is determined by amount of data to be stored. Normally it will be impossible to store enough data on the disc to fill the directory. The disc is formatted as follows:

1. Enter the [Storage Operation] field and place the cursor in the Operation field and press PREV[], NEXT[] keys until [Format disc] is displayed. No other selections are required. Press the INSERT key. The message "Enter "Y" to confirm >_" is displayed. The cursor must be moved to the entry field following the > and a "y" placed in that field.

CAUTION

Anything stored on the disc that is being formatted will be erased during the Format Disc operation.

Appendix E. Using The Tape Memory Accessory

Introduction	E-1
How To Use Tape Memory Accessory	E-1
How To Create A New File	E-4
How To Read A File	E-4
How To Copy An Existing File From One Tape To Another	E-4

Appendix E

Using The Tape Memory Accessory

INTRODUCTION

This appendix describes how to use the HP 82161A Digital Cassette Drive as an accessory to store and load test setups and captured data for the analyzer. It also describes how to copy files from one tape cassette to another.

The digital cassette drive obtains its operating power from its internal battery pack (charged from its power connector). When operating the digital cassette drive with a connection to 110V, use the ON position of the power switch. Use the STANDBY position when operating the digital cassette drive from its internal battery pack without a connection to 110V. The 110V connection provides maximum charge to the battery pack when the power switch is OFF.

When the digital cassette drive is connected to the analyzer, you can obtain the [Tape Operations] menu shown in figure E-1 (part of the set of SYSTEM menus).

HOW TO USE TAPE MEMORY ACCESSORY

The following procedure will help you become familiar with how to use the tape memory accessory, if you have the HP 82161A Digital Cassette Drive accessory for your analyzer.

1. Connect the operating power cord to the digital cassette drive and to a source of operating power.
2. Connect the two HP-IL interface cables to the analyzer rear panel and to the digital cassette drive. Note the different shapes of the two HP-IL connectors.
3. Turn on operating power on the panel of the digital cassette drive.
4. Press the OPEN button on the digital cassette drive, install a blank tape cassette, and close the cassette door.
5. Press the SYSTEM key on the analyzer keyboard.
6. Press the NEXT[] key to obtain the [Tape Operations] menu. The analyzer will only display this menu when it has the tape memory accessory connected. See figure E-1.

NOTE

Figure E-1 shows all of the possible entries for the [Tape Operations] menu. File 1 is an HP-supplied inverse-assembler file. File 2 is a user-generated file with the date and time of its creation. File 10 is a copyfile; it allows copying of write protected files from one tape to another. The remaining files have no data stored.

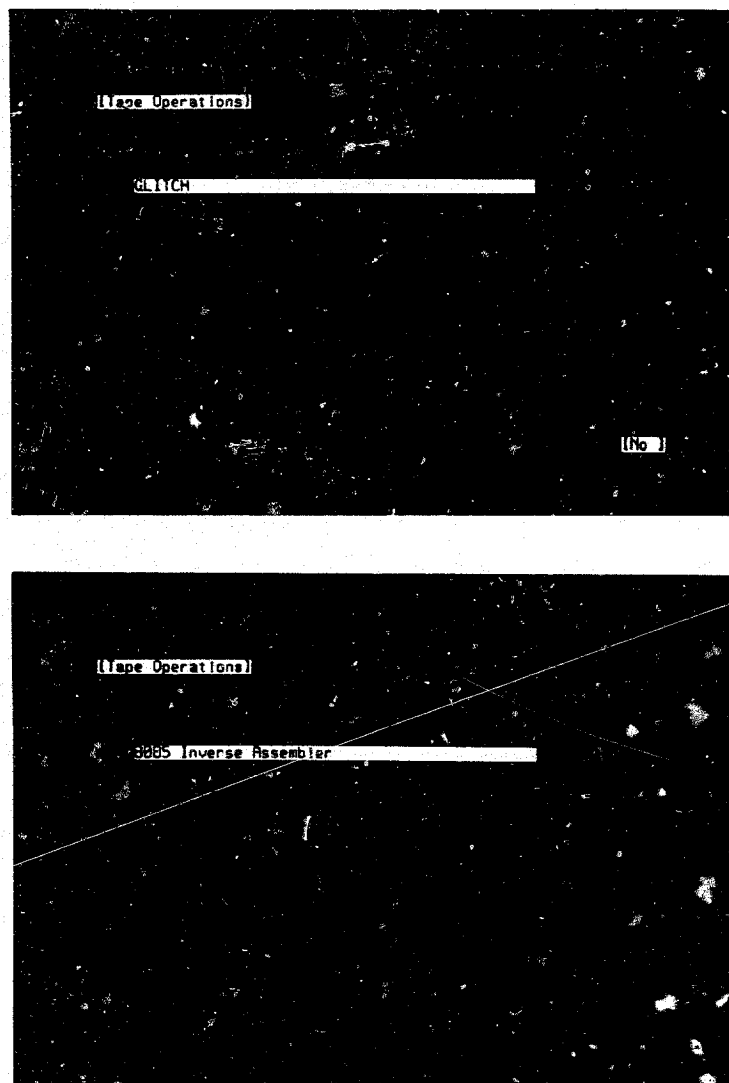

Files

- Number of files: 10 files fixed. Selected using ROLL Keys.
- User File Names: all upper case.
- HP-supplied file names: file name is preceded by an asterisk. These files are write-protected and cannot be reformatted.
- File contents: configurations for menus (System, Trace, and Format), contents of trace memory (List, Waveform, X-Y Chart, and histogram chart displays, including data and time if clock was set).

Display Control Fields

- File Description: bright bar (moved with ROLL keys) indicates file that will be read with INSERT and written to with DELETE.
- Erase & Format Cassette: [Yes] automatically erases entire tape and reformats to 10 blank files. When using a cassette with one or more write-protected files, the erase function is not available and the field is not displayed.

Figure E-1. Tape Operations System Menu

7. Move the cursor down into the Erase & Format Cassette field and change it to [Yes]. This will immediately cause the analyzer to erase everything on the tape and format ten blank files. This operation takes approximately 5 minutes. All other functions of the analyzer can be used while it is formatting the tape.

NOTE

You cannot erase and format a tape that has any write-protected files.

8. When tape formatting is complete, the display will show No Data for each file. Move the cursor into the bright bar in the File Description column, and Type in the letter A. This assigns file name A to the associated file space. Now you can save the setups of the FORMAT and TRACE menus, and the content of the trace memory on tape in file A.
9. The analyzer would identify the date and time that it saved your setup and data, and make this information available to you if you had set the analyzer clock, but it is not set.
10. Try going to the [Peripherals] menu to set the clock. The ERROR message indicates that you cannot leave this file until you store information in it. Since you don't want to store the instrument setup until you can identify the date and time of storage, press the blue SHIFT key and press DEFAULT. This returns the file to the undefined state.
11. Move the cursor up into the [Tape Operations] field and change it to [Peripherals].
12. Move the cursor down into the "Clock Set:" field and enter the month, day, year, and time (hour:minute:second).
13. Press the TRACE key, and change the trace mode field to read [Continuous].
14. Press the RUN key and then the STOP key. This obtains data in memory.
15. Press the SYSTEM key and obtain the [Tape Operations] menu.
16. Move the cursor into the bright bar in the File Description column and type in the letter A. This assigns file A to store the instrument setup and acquired data at the indicated location on the tape.
17. Press the blue SHIFT key and DELETE to write your present instrument setup on the tape. The message WAIT Writing Cassette File will be on screen while the analyzer is writing the setup and data.
18. After tape storage is complete and the tape has been rewound, cycle the LINE power switch off and back on. The System Specification [Configuration] menu will be on screen. The analyzer will loose its clock set.
19. Press the TRACE key. See that the [Single] trace mode is in effect. This is the default mode set up during power-up.
20. Press the LIST key. See that the trace list memory is blank.
21. Press the SYSTEM key and change [Configuration] to [Tape Operations]. See that your file A is identified on screen, along with the date and time it was stored. The bright bar in the File Description column should be on your file A. Use ROLL keys to move bright bar, if necessary.
22. Press the INSERT key. The message WAIT Reading Cassette File will be on the display. Allow several seconds for the analyzer to read the file and set up the menus. When the reading of the file is complete, the SYSTEM [Configuration] menu will be on screen.

23. Press the TRACE key. See that the trace specification is set up to perform in the [Continuous] trace mode. This is the measurement mode you recorded on tape.
24. Press the LIST key. See that the trace memory is loaded with activity. This is the activity that was in the trace memory when you recorded the setup.

HOW TO CREATE A NEW FILE

1. Place the cursor in the bright bar under File Description.
2. Use the ROLL keys to move the bright bar to the desired location for the new file.
3. On the keyboard, type in a file name using any of the alphanumeric characters. After the name of a file has been typed, you cannot access any other part of the analyzer until you store an instrument setup plus data in that file. If you have to leave that file location before storing the setup and data, press the blue SHIFT key and DEFAULT.
4. Press the blue SHIFT key and DELETE to write the analyzer setup and data to the selected tape file. This takes from 30 to 70 seconds, approximately.

NOTE

For ease of creating a file description similar to one already on screen, move the bright bar into the present file name and type just the first letter of that name. Then ROLL the bright bar to the location where you want to create the new name. A copy of the entire line will follow the bright bar. You can edit the copy to obtain the File Description you want.

HOW TO READ A FILE

1. Use the ROLL keys to move the bright bar to the location of the file you want to read.
2. Press the INSERT key. The message WAIT Reading Cassette File will appear on screen. The read takes from 20 to 60 seconds, approximately. When the read is complete, the [Configuration] System Specification will appear on screen.

HOW TO COPY AN EXISTING FILE FROM ONE TAPE TO ANOTHER

You can make as many copies of your user files as desired by following the procedures described in this appendix. First load your file into the analyzer as described in "How To Read A File". Then write the analyzer setup to as many other cassettes as desired, as described in "How To Create A New File".

HOW TO COPY AN HP WRITE-PROTECTED INVERSE-ASSEMBLER FILE INTO A USER FILE

All tape cassettes have a finite life. You should make user copies of your cassettes that have HP-supplied inverse-assembler files. Then store the original tapes; use them only when making new user copies. The following procedure will help you create user copies of HP-supplied inverse-assembler files.

1. Install the tape cassette that has the HP write-protect inverse-assembler file into the digital cassette drive.
2. Obtain the [Tape Operations] menu. Each cassette with an HP-supplied inverse-assembler file will have an additional file labeled, "COPYFILE: Duplicates cassette files". This contains the routines that read an HP-supplied inverse-assembler, and copy it to other cassettes.

3. Move the highlighted bar to the "COPYFILE" line.
4. Press the INSERT key. This causes the analyzer to read the COPYFILE program. When finished, the analyzer will place the following messages on screen: "COPYFILE: Press INSERT to copy highlighted file" at the bottom of the menu, and "Press STOP to exit COPYFILE" at the top of the menu.
5. Move the highlighted bar to the write-protected inverse-assembler file you want to copy.
6. Press the INSERT key. This reads the inverse-assembler file into the analyzer along with the copyfile program. When finished, the message at the bottom of the menu will change to "COPYFILE: Press DELETE to store copy in highlighted file".
7. Now open the digital cassette drive, remove the tape cassette, and install the new cassette that you want to contain your user file. The analyzer will display the directory of the new tape.
8. Move the highlighted bar to the location where you want to store the inverse-assembler routine.
9. Press the DELETE key. The analyzer will write the inverse-assembler routine to the tape at the location you selected. All attributes of the source file will be transferred. Because the source file was write-protected, your user file will also be write-protected.
10. You can now repeat steps 7 through 9 to create as many cassettes with inverse-assembler routines as desired.
11. Press the STOP key. This exits the COPYFILE program and returns the analyzer to normal program execution.

INDEX

A

Accessories	1-4
Accessory power	2-2
Address switch	2-1
[Assignment] menu	4-4
Assignments	
Clock	4-5
Labels	4-6
Threshold	4-5
Polarity	4-6

B

Blue shift key	3-0,4-3
Bus, HP-IB	Appendix 3

C

Capturing state flow	4-1
Clock assignments	4-5
Clock set	8-1,8-2
Compare trace modes	
[Compare/Edit Compare]	4-27
[Full Compare]	4-29
[Configuration] menu	4-2, 6-2, 7-2
Configuration, Physical	1-4
Connections	
to target system	2-1
through probe interface	2-
directly to system	
operating power	
[Continuous] trace mode	4-15
in compare modes	4-27
in overview modes	5-1
Control	
front panel	3-0
HP-IB	9-1
HP-IL	9-1
Count	
[states] or [time]	4-16
CURSOR	3-0

D

Display messages	Appendix A
Display messages, power-up	2-4
DON'T CARE triggering	4-18

E	
Error messages	Appendix A
F	
Free-run trace	4-1
FORMAT Specification, State	
description	1-3
[Assignment]	4-7
[Relocation]	4-10
[User Base]	4-13
FORMAT Specification, Timing	
[Assignment]	6-7
[User Base]	6-8
G	
Glitches	6-1
Glitch mode	6-9
H	
Hardcopy, printer	C-1
Histogram	5-1
state label overview	5-4
state time interval overview	5-6
state time position overview	5-8
state linkage overview	5-12
HP-iB	Appendix B
HP Model 5036A	4-1
HP Model 9121D/S	1-4, Appendix D
HP Model 10269A/B	1-4, 2-2
HP Model 10271A	1-4
HP Model 10272A	1-4
HP Model 10273A	1-4
HP Model 82161A	1-4, Appendix E
I	
Interactive state/timing	7-1
triggering	7-1
FORMAT	7-3
TRACE	7-3
Interface	
HP-IB or HP-IL	9-1
Probe	1-4, 2-2
Internal storage	
description	1-3
storing to	8-4
resetting	2-3
Inverse Assemblers	4-15

L

Labels

- moving on display 4-3
- state 4-6
- timing 6-7

Learn string commands

- TC, transmit configuration 9-5
- TE, transmit everthing 9-9
- TS, transmit state acquisition 9-6
- TT, transmit timing acquistion 9-8

LIST displays

- state 4-31
- timing 7-5

[Linkage] overview measurement 5-10

M

Magnification 6-4

Magnify about "x" 6-3

Master field 7-4

Memory

- description 1-4
- tape Appendix E
- disc 8-2, Appendix D

Menu map 3-2

Messages

- ERROR Appendix A
- WARNING Appendix A
- WAIT Appendix A
- power-up 2-4

Mnemonics 9-1

Multiple labels for bits 4-9

N

[next to] 4-23

O

Operating characteristics 1-7

[Overview] measurements 5-1

- [State Label] 5-1
- [Time Interval] 5-4
- [Time Position] 5-6
- [Linkage] 5-10

P

Performance analysis, software 5-1

Peripherals

- tape memory Appendix E
- disc memory Appendix D
- printer Appendix C

P (Continued)

[Peripherals] menu	8-1
1630A/D	8-2
1630G	2-2, 4-5
Pod threshold	8-2, 8-3
PORT, rear panel	3-0
PRINT	1-4, Appendix E
Printer	1-4, 2-2
Probe Interface	

R

[Relocation] menu	4-10
Resource terms	4-19
sequence restart	4-24
store qualifiers	4-25
[then]	4-22
trigger [center]	4-21
trigger [end]	4-21
trigger [start]	4-19
[next to]	4-23
Restart, sequence	4-24
RESUME	3-0
RETURN TO LOCAL	3-0
RUN	3-0, 4-1

S

Sample period	6-10
Self-test	2-2
1630A/D	2-3
1630G	2-3
Sequence triggering	4-22
sequence restart	4-24
store qualifiers	4-25
[then]	4-22
trigger [center]	4-21
trigger [end]	4-21
trigger [start]	4-19
[next to]	
Service	2-2
[Single] trace mode	4-15
Specifications	1-5
State Analysis Functions	1-2
State DISPLAYS	
LIST	4-31
WFORM	4-33
CHART	4-34
State FORMAT Specification	4-4
[Assignment]	4-6
[Relocation]	4-10
[User Base]	4-13

S (Continued)

State Label Overview Measurement 5-1

State TRACE Specification 4-15

 [Single] 4-15

 [Continuous] 4-15, 4-27, 4-30

 [Compare/Edit Compare] 4-27

 [Full Compare] 4-30

 [Overview] 5-1

 Time tagging 4-16

[Storage Operations] menu D-1

Store qualifiers 4-25

SYSTEM Specification, description 1-3

SYSTEM menus

 [Configuration] 4-2

 [Peripherals] 8-1

 [Storage Operations] Appendix D

 [Tape Operations] Appendix E

T

TALK ONLY mode C-1

Tape memory Appendix E

[Tape Operations] menu Appendix E

Target system 4-1

Termination of transfer 9-9

[Time Interval] overview measurement 5-4

[Time Positional] overview measurement 5-6

Time tagging 4-16

Timing Analysis Functions 1-2

Timing DISPLAYS

 WFORM 6-10

 LIST 6-11

 CHART 6-12

Timing FORMAT Specification 6-7

 [Assignment] 6-7

 [User Base] 6-8

Timing measurements 6-1, 7-1

Timing TRACE Specification 6-9

 [Single] 6-9

 [Continuous] 6-9

Transfer termination 9-9

Trigger [center] trace 4-21

Trigger edge 6-5

Trigger [end] trace 4-19

Trigger, DON'T CARE 4-18

Trigger [start] trace 4-19

Trigger terms 4-19

U

[User base] menu 4-13

W

Waveform Displays 4-33
 State 4-33
 Timing 6-10

X

XY Chart Displays 4-34
 State 4-34
 Timing 6-12